

**EMS TWEEZERS LINE**

**DUMONT TWEEZERS**

**RUBIS TWEEZERS**

**PLASTIC TWEEZERS**

# **EMS TWEEZERS**

**Acquista almeno  
3 pinzette (a scelta) e avrai uno  
SCONTO del 30%!!!**

Catalogo completo Pinzette per Microscopia Elettronica :

[https://www.sichim.com/files/ugd/532628\\_e02b9a3723ea4e8bbddb6778905245da.pdf](https://www.sichim.com/files/ugd/532628_e02b9a3723ea4e8bbddb6778905245da.pdf)

**Condizioni d'offerta:**

Prezzi: al netto dell' IVA (22%)

Ordine Minimo: €120.00 (IVA esclusa)

Spese di Spedizione: €15,00

Scadenza offerta: 30 Giugno 2024

Per ordini e/o informazioni contattare:

**Società Italiana Chimici**

e-mail: [offerte@sichim.com](mailto:offerte@sichim.com)

Condizioni di Vendita consultabili alla pagina:

[https://www.sichim.com/files/ugd/532628\\_31b8b932d9074d5ba6feba3875166274.pdf](https://www.sichim.com/files/ugd/532628_31b8b932d9074d5ba6feba3875166274.pdf)



# EMS TWEEZERS CATALOG

HIGH PRECISION AND ULTRA FINE TWEEZERS, **BIOLOGY TWEEZERS**, MEDICAL TWEEZERS, **GOLD PLATED TWEEZERS**, SURFACE MOUNT AND OPTOELECTRONIC TWEEZERS, **MINI TWEEZERS**, CUTTING TWEEZERS, **WAFER TWEEZERS**, PLASTIC TWEEZERS, **COMPONENT POSITIONING TWEEZERS**, HEAVY-DUTY TWEEZERS, **COATED TWEEZERS**, AND MORE



The C-flat™ Family of Holey Carbon, Gold TEM Grids

now by EMS...

C-flat™ by EMS  
in numerous  
configurations

Au-flat™ by EMS  
for high resolution  
imaging

CD-flat™ by EMS  
for automated S/TEM  
imaging and metrology

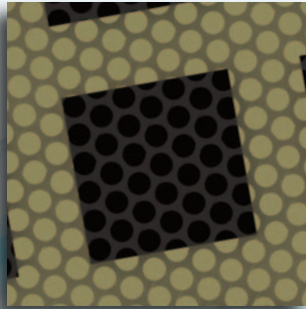
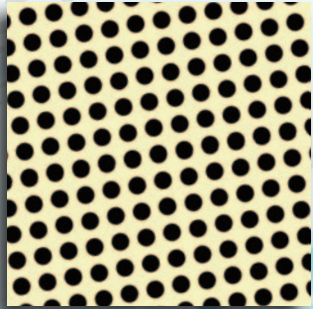
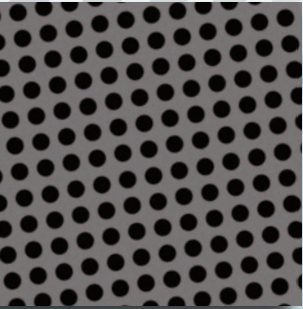

You can count on the same advantages, the same high quality, and the same product selection that makes the C-flat Family the premier holey carbon/gold grids for S/TEM and Cryo-TEM.



EMS has it!

everything a lab  
could need...

NIGHTSEA  
Fluorescence Viewing Systems



For many years, NIGHTSEA has developed practical and economical solutions for viewing and photographing fluorescence in the lab and in the field. *Electron Microscopy Sciences is happy to announce that NIGHTSEA is now part of the EMS Family of Companies.*

#### APPLICATIONS...

- Pre-screening
- Microdissection
- Failure Analysis
- Genotype Sorting
- Forensics

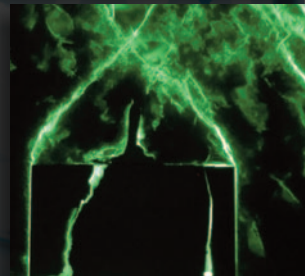
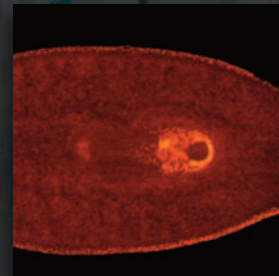
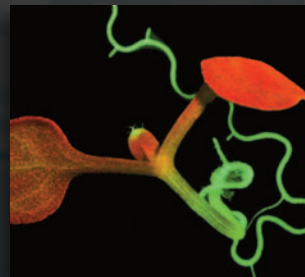

Electron  
Microscopy  
Sciences

P.O. Box 550 • 1560 Industry Rd. • Hatfield, Pa 19440  
Tel: (215) 412-8400 • Fax: (215) 412-8450  
email: info@emsdiasum.com • www.emsdiasum.com

## TABLE OF CONTENTS

	PAGE NO.
<b>EMS LINE OF TWEEZERS</b> .....	<b>2-49</b>
High Precision and Ultra Fine Tweezers...2-7	Reverse Action...7
Biology Tweezers...8	Mini Tweezers...9
Economy Tweezers...10-11	Boley Tweezers...11
Premium Economy Tweezers...12-13	Standard Tweezers...14-15
High End Medical Tweezers...16	Gold Plated Tweezers...17
ESD Diamond Coated Tweezers...18-19	ESD Rubber Tweezers...20-21
ESD Epoxy Coated Tweezers...22-23	
Surface Mount and Optoelectronic Tweezers...24-25	
PTFE Coated Tweezers...26-27	ESD Foam Tweezers...28
Component Positioning Tweezers...29	
Super Slim and Long Tweezers...30	Flat-Tip Tweezers...30-31
Heavy Duty Tweezers...32-33	Cutting Tweezers...34-35
Wafer Tweezers...36-39	General Purpose Tweezers...40
Fiber Tip Tweezers...41	Plastic Replaceable Tip Tweezers...42-45
Ceramic Replaceable Tip Tweezers...46-47	Full Ceramic Tweezers...47
Full Plastic Tweezers...48-49	Carbon Fiber Soft Tip Tweezers...49
<b>DUMONT TWEEZERS</b> .....	<b>50-83</b>
Overview...50	Standard, Biological, and Electronic Grades, Positive Action...51-60
Medical Grade...61-63	
Standard, Biological, and Electronic Grades, Negative Action...64-65	
Electronics and Micro-Electronics Tweezers, Positive Action...66-70	
Diamond Tweezers...69	Mini Tweezers...69
Tweezer Sets...70	
Electronics and Micro-Electronics Tweezers, Negative Action...72-73	
Ergonomic ESD Tweezers...74	ESD Tweezers...75
Component Handling Tweezers...76	Wafer Handling Tweezers...76
Instruments for Chemistry, Radiochemistry, and Radiation Metrology...77	Tweezers and Replaceable Tips...78-83
WA Tweezer Handles...83	
<b>RUBIS TWEEZERS</b> .....	<b>84-96</b>
Overview...84	Axal Tweezers...85
Ion Tweezers...86	
Grip Tweezers...87	DURAX™ Tweezers...88
Nano Tweezers...89	
ESD Rubber Handle Tweezers...90-91	Precision Tweezers...92
Specialty Tweezers...93	Standard SA Steel Tweezers...94
Reinforced Plastic Tweezers...95	Tech Plus Tweezers...94
Wafer Tweezers...96	



### High Precision Tweezers Kit

Available in Anti-Acid/Anti-Mag SS, Titanium, or Superalloy.  
See page 6.



### Dumont Tweezer Boxes

For 3, 5, or 7 Tweezers.  
See page 70.



### Rubis DURAX™ Tweezers

Available in Anti-Acid/Anti-Mag SS, Titanium, or Superalloy.  
See page 88.



### Carbon Fiber Soft Tip Tweezers

Specially designed to handle sensitive objects.

See page 49.

## Electron Microscopy Sciences

P.O. Box 550 • 1560 Industry Rd.  
Hatfield, PA 19440

Tel: (215) 412-8400

Fax: (215) 412-8450

email: [info@emsdiasum.com](mailto:info@emsdiasum.com)

or [stacie@ems-secure.com](mailto:stacie@ems-secure.com)

[www.emsdiasum.com](http://www.emsdiasum.com)



EMS LINE OF TWEEZERS

High Precision and Ultra Fine Tweezers

Handcrafted precision tweezers have a perfect tip symmetry and balance, polished edges, and a superior no-scratch/antiglare satin finish. The right tweezers and material for a successful application. High precision tweezers are available in anti-magnetic anti-acid stainless steel (SA).

- Low carbon austenitic steel (Material number 1.4435, DIN X2CrNiMo18-14-3, AISI number 316L)
- Contains from 16.5 to 18.5 wt% chromium and has important quantities of nickel and molybdenum as additional alloying elements
- Non-magnetizable
- Good corrosion resistance to most chemicals, salts and acids
- Generally used where corrosion resistance and toughness are primary requirements
- Typical applications include tweezers for the electronic industry, watch-makers, jewelers and laboratory and medical applications in moderately aggressive chemical environments

TIP DIMENSION GUIDE:

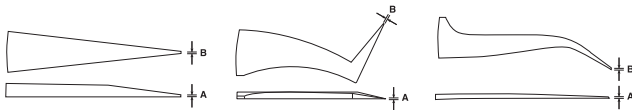

III Style 0

High precision tweezers with fine tips. Length: 120mm



Cat. No.	Material	A mm	B mm	Pkg.
78310-0	Anti-Acid/Anti-Mag SS	0.10	0.15	each
78510-0	Superalloy AntiAcid/AntiMag	0.10	0.15	each

III Style 0R, Locking

Flat edges with fine tips and locking system. Length: 120mm



Cat. No.	Material	A mm	B mm	Pkg.
78511-0R	Anti-Acid/Anti-Mag SS	0.10	0.15	each

III Style 00

High precision tweezers with strong, thick tips. Length: 120mm



Cat. No.	Material	A mm	B mm	Pkg.
78311-00	Anti-Acid/Anti-Mag SS	0.50	0.90	each

III Style 00B

High precision tweezers with strong, thick tips. Length: 120mm



Cat. No.	Material	A mm	B mm	Pkg.
78311-00B	Anti-Acid/Anti-Mag SS	0.55	0.90	each

III Style 00D

High precision tweezers with strong, thick tips. Length: 120mm



Cat. No.	Material	A mm	B mm	Pkg.
78311-00D	Anti-Acid/Anti-Mag SS	0.45	0.90	each

III Style 000

High precision tweezers with fine tips. Length: 120mm



Cat. No.	Material	A mm	B mm	Pkg.
78312-000	Anti-Acid/Anti-Mag SS	0.17	0.20	each

III Style 0C9

High precision tweezers with fine tips. Length: 90mm



Cat. No.	Material	A mm	B mm	Pkg.
78511-0C9	Anti-Acid/Anti-Mag SS	0.10	0.15	each

III Style 0A

Straight point with radiused outside edges, fine tips. Length: 120mm



Cat. No.	Material	A mm	B mm	Pkg.
72919-0A	Anti-Acid/Anti-Mag SS	0.10	0.15	each

III Style 1

High precision tweezers with fine tips. Length: 120mm



Cat. No.	Material	A mm	B mm	Pkg.
78316-1	Anti-Acid/Anti-Mag SS	0.11	0.14	each
78516-1	Superalloy AntiAcid/AntiMag	0.1	0.15	each
78511-01	Titanium Alloy	0.1	0.15	each

III Style 1R, Locking

Strong, straight, fine tips, with locking system. Length: 120mm



Cat. No.	Material	A mm	B mm	Pkg.
78511-1R	Anti-Acid/Anti-Mag SS	0.11	0.14	each

## High Precision and Ultra Fine Tweezers (continued)

## III Style 2

High precision tweezers with sharp, fine tips. Length: 120mm



Cat. No.	Material	A mm	B mm	Pkg.
78317-2	Anti-Acid/Anti-Mag SS	0.07	0.13	each
78517-2	Superalloy AntiAcid/AntiMag	0.05	0.15	each

## III Style 2A

High precision tweezers with flat, accurate, round tips. Provides a larger flat gripping surface for better handling of small objects without puncturing the membrane, wafer etc. Length: 120mm



Cat. No.	Material	A mm	B mm	Pkg.
72919-2A	Anti-Acid/Anti-Mag SS	0.07	1.70	each
72919-2ANC	Superalloy AntiAcid/AntiMag	0.05	1.65	each
72919-2ATe	Anti-Acid/Anti-Mag SS, "PTFE" Coating	0.07	1.70	each
72919-2ATa	Titanium Alloy	0.05	1.65	each

## III Style 2B

High precision tweezers with flat, accurate, round tips. Provides a larger flat gripping surface for better handling of small objects without puncturing the membrane, wafer etc. Length: 120mm



Cat. No.	Material	A mm	B mm	Pkg.
72919-2AB	Anti-Acid/Anti-Mag SS	0.11	1.50	each
72919-2ABTe	Anti-Acid/Anti-Mag SS, "PVDF" Coating	0.11	1.50	each

## III Style 2AZ

Same tips as 2A but 'Z' shaped. Length: 120mm



Cat. No.	Material	A mm	B mm	Pkg.
78317-2AZ	Anti-Acid/Anti-Mag SS	0.10	1.65	each

## III Style 2AR, Locking

Flat accurate round tips, with locking system. Length: 120mm



Cat. No.	Material	A mm	B mm	Pkg.
78511-2AR	Anti-Acid/Anti-Mag SS	0.07	1.70	each

**Technical Tip** For our EM users, the tweezer styles #3, #3C, #4, #5, #51S, and 5B are all recommended for the precise handling of all EM grids.

## III Style 3

High precision tweezers with very sharp, fine tips. Length: 120mm



Cat. No.	Material	A mm	B mm	Pkg.
78318-3	Anti-Acid/Anti-Mag SS	0.09	0.16	each
78518-3	Superalloy AntiAcid/AntiMag	0.10	0.15	each
78318-3GP	Gold Plating	0.10	0.15	each
78512-3	Titanium Alloy	0.15	0.20	each

## III Style 3C

High precision tweezers with very sharp, fine tips. Shorter than Style 3. Length: 110mm



Cat. No.	Material	A mm	B mm	Pkg.
78318-3C	Anti-Acid/Anti-Mag SS	0.10	0.20	each
78518-3C	Superalloy AntiAcid/AntiMag	0.10	0.20	each
78318-3CTa	Titanium Alloy	0.10	0.20	each
78512-3C	Carbon Steel	0.10	0.20	each

## III Style 3CB

Very sharp, superior finish, bent tips. Length: 110mm



Cat. No.	Material	A mm	B mm	Pkg.
78318-3CB	Anti-Acid/Anti-Mag SS	0.10	0.20	each

## III Style 3F

Tips touching over 3mm (parallel tips), useful for handling tiny wires. Length: 120mm



Cat. No.	Material	A mm	B mm	Pkg.
78318-3F	Anti-Acid/Anti-Mag SS	0.10	0.20	each

## III Style 3SA

Tips touching over 3mm (parallel tips), useful for handling tiny wires. Length: 120mm



Cat. No.	Material	A mm	B mm	Pkg.
78318-3SAte	Anti-Acid/Anti-Mag SS, "PTFE" Coating	0.1	0.15	each

EMS LINE OF TWEEZERS

High Precision and Ultra Fine Tweezers (continued)

III Style 4

High precision tweezers with extra fine tips. Length: 110mm



Cat. No.	Material	A mm	B mm	Pkg.
78319-4	Anti-Acid/Anti-Mag SS	0.11	0.16	each
78519-4	Superalloy AntiAcid/AntiMag	0.10	0.15	each

III Style 4R, Locking

Straight, extra fine tips, superior finish, with locking system. Length: 120mm



Cat. No.	Material	A mm	B mm	Pkg.
78512-4R	Anti-Acid/Anti-Mag SS	0.07	1.70	each

III Style 4A

Extra fine and strong tips. Length: 110mm



Cat. No.	Material	A mm	B mm	Pkg.
78319-4A	Anti-Acid/Anti-Mag SS	0.151	0.35	each

III Style 5

Extra fine tips, superior finish. Length: 110mm



Cat. No.	Material	A mm	B mm	Pkg.
78320-5	Anti-Acid/Anti-Mag SS	0.06	0.10	each
78520-5	Superalloy AntiAcid/AntiMag	0.06	0.10	each
78320-5Te	"PTFE" Coating	0.06	0.10	each
78320-5GP	Gold Plating	0.06	0.10	each
78325-5S	Stainless Steel	0.06	0.10	each
78320-5Ti	Titanium Alloy	0.06	0.10	each

III Style 5R, Locking

Straight, extra fine tips, superior finish, with locking system. Length: 110mm



Cat. No.	Material	A mm	B mm	Pkg.
78325-5R	Anti-Acid/Anti-Mag SS	0.06	0.10	each

III Style 5A

Extra fine tips. Length: 115mm



Cat. No.	Material	A mm	B mm	Pkg.
78320-5A	Anti-Acid/Anti-Mag SS	0.08	0.13	each

III Style 5B

Extra fine, bent tips, maximum visibility. Length: 110mm



Cat. No.	Material	A mm	B mm	Pkg.
78320-5B	Anti-Acid/Anti-Mag SS	0.06	0.10	each

III Style 5BR

Extra fine, bent tips, maximum visibility, with locking system. Length: 110mm



Cat. No.	Material	A mm	B mm	Pkg.
78325-5BR	Anti-Acid/Anti-Mag SS	0.06	0.10	each

III Style 5C

Extra fine, double bent tips. Length: 115mm



Cat. No.	Material	A mm	B mm	Pkg.
78320-5C	Anti-Acid/Anti-Mag SS	0.07	0.10	each
78520-5C	Superalloy AntiAcid/AntiMag	0.07	0.10	each

III Style 5TTH

Anti-capillary, extra fine tips with locking ring. Useful for handling EM grids. Length: 110mm



Cat. No.	Material	A mm	B mm	Pkg.
78320-5TTH	AntiAcid/AntiMag SS	0.09	0.14	each
78520-5TTH	Superalloy AntiAcid/AntiMag	0.09	0.14	each

III Style 6

High precision tweezers with angled, flat, fine tips. Length: 120mm



Cat. No.	Material	A mm	B mm	Pkg.
78321-6	Anti-Acid/Anti-Mag SS	0.08	0.18	each

High Precision and Ultra Fine Tweezers (continued)

III Style 7

High precision tweezers with very fine, curved tips.. Length: 120mm



Cat. No.	Material	A mm	B mm	Pkg.
78322-7	Anti-Acid/Anti-Mag SS	0.09	0.16	each
78522-7	Superalloy AntiAcid/AntiMag	0.09	0.16	each
78322-7Te	"PTFE" Coating	0.09	0.16	each
78322-7GP	Gold Plating	0.09	0.16	each
78322-7Ti	Titanium Alloy	0.09	0.16	each

III Style 7A

High precision tweezers with angled, flat, fine tips. Length: 120mm



Cat. No.	Material	A mm	B mm	Pkg.
78325-7A	Anti-Acid/Anti-Mag SS	0.15	0.26	each

III Style 7R, Locking

Very fine, curved tips, with locking system. Length: 110mm



Cat. No.	Material	A mm	B mm	Pkg.
78325-7R	Anti-Acid/Anti-Mag SS	0.09	0.16	each

III Style 7B

Fine, curved and serrated tips. Length: 115mm



Cat. No.	Material	A mm	B mm	Pkg.
78325-7B	Anti-Acid/Anti-Mag SS	0.14	0.19	each

III Style 7E

Fine, curved tips and flat edges. Length: 115mm



Cat. No.	Material	A mm	B mm	Pkg.
78325-7E	AntiAcid/AntiMag SS	0.14	0.19	each

III Style 10G

High precision tweezers with serrated handles and fine, line serrated tips. Length: 110mm



Cat. No.	Material	A mm	B mm	Pkg.
78324-10G	Anti-Acid/Anti-Mag SS	0.45	0.55	each

III Style 26

Very strong, sharp tips. Length: 135mm



Cat. No.	Material	A mm	B mm	Pkg.
78328-26	Nickel	0.2	0.2	each

III Style 27

Straight, strong, sharp, fine tips, superior finish. Length: 135mm



Cat. No.	Material	A mm	B mm	Pkg.
78511-27	Anti-Acid/Anti-Mag SS	0.12	0.3	each

III Style 51S

Extra fine, bent tips. Useful for handling EM grids. Length: 115mm



Cat. No.	Material	A mm	B mm	Pkg.
78340-51S	Anti-Acid/Anti-Mag SS	0.04	0.12	each
78325-51S	Titanium	0.04	0.12	each

EMS EXCLUSIVE

III Style 62A

Ideal for handling coverglass.

Flat, blunt tips. Length: 120mm



Cat. No.	Material	A mm	B mm	Pkg.
78350-62A	Anti-Acid/Anti-Mag SS	2.5	2.5	each

III Style 65A

Sharp, bent tips. Length: 140mm



Cat. No.	Material	A mm	B mm	Pkg.
78351-65A	Anti-Acid/Anti-Mag SS	0.07	0.15	each



EMS LINE OF TWEEZERS

High Precision and Ultra Fine Tweezers (continued)

III Style AA

Boley tweezers, straight, sharp, fine tips. Length: 130mm



Cat. No.	Material	A mm	B mm	Pkg.
78325-AASA	Anti-Acid/Anti-Mag SS, "PTFE" Coated	0.15	0.35	each

III Style AC

Serrated handles, straight, strong tips, superior finish. Length: 110mm



Cat. No.	Material	A mm	B mm	Pkg.
78325-AC	Anti-Acid/Anti-Mag SS	0.15	0.35	each

III Style SS

High precision tweezers with flat, squared head, thin, strong tips. Length: 140mm



Cat. No.	Material	A mm	B mm	Pkg.
78325-SS6	Anti-Acid/Anti-Mag SS	0.09	0.12	each
78325-SSSA	Anti-Acid/Anti-Mag SS, "PTFE" Coated	0.09	0.12	each

III Kits of High Precision Tweezers

High precision tweezers sets encased in top quality hard/foam wallet. Tweezers also available individually.



Kit of 5 High Precision Tweezers — Anti-Acid/Anti-Mag SS

Includes styles 00, 2A, 3C, 5, 7.

Cat. No.	Description	Pkg.
78325-01	Tweezer Kit, High Precision, Stainless Steel	kit

Kit of 5 High Precision Tweezers — Titanium

Includes styles 1, 2A, 3C, 5, 7.

Cat. No.	Description	Pkg.
78325-02	Tweezer Kit, High Precision, Titanium	kit

Kit of 5 High Precision Tweezers — Superalloy Anti-Acid/Anti-Mag

Includes styles 1, 2A, 3C, 5, 7.

Cat. No.	Description	Pkg.
78327-01	Tweezer Kit, High Precision, Superalloy	kit

Kit of 5 High Precision Tweezers — Anti-Acid/Anti-Mag SS

Includes styles 1, 2A, 3C, 5, 7.

Cat. No.	Description	Pkg.
78327-02	Tweezer Kit, High Precision, Stainless Steel	kit

III Style AM

High precision tweezers: straight, pointed, thick tips. Length: 125mm



Cat. No.	Material	A mm	B mm	Pkg.
AM.BR	Brass	0.21	0.32	each

III Style F

Straight, flat, squared head, thin, strong tips, superior finish. Length: 120mm



Cat. No.	Material	A mm	B mm	Pkg.
78551-65A	Superalloy AntiAcid/AntiMag	0.07	0.15	each
78325-F	Anti-Acid/Anti-Mag SS	0.08	1.70	each

III EMS Tweezers Sets in Wooden Case

Set 1

For fine and precision work, this set includes one each of:

- Style 3 (#78318-3),
- Style 4 (#78319-4),
- Style 5 (#78320-5),
- Style 5A (#78320-5A),
- and Style 7 (#78322-7)

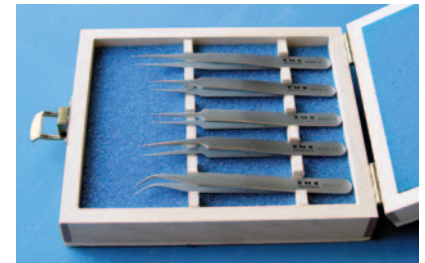

Cat. No.	Description	Pkg.
78323-01	Fine EMS Tweezers Set 1	5/set

Set 2

For general fine and miniature work, this set includes one each of:

- Style 0 (78310-0),
- Style 00B (&8313-00B),
- Style 2 (#78317-2),
- Style 2A (#72919-2A) and
- Style 2AX (78317-2AX)



Cat. No.	Description	Pkg.
78323-02	Fine EMS Tweezers Set 2	5/set

High Precision and Ultra Fine Tweezers (continued)

**EMS Reverse Action Tweezers**

Uniform tension in handling small fragile parts for extended periods of time without finger strain. Specially intended for applications where a highly precise self-closing action is required such as in microscopy and assembly applications.

**TIP DIMENSION GUIDE:**

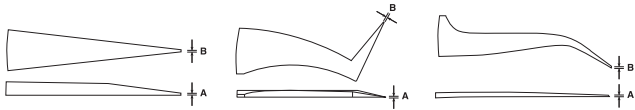

**III Style 2AX**

Reverse action tweezers: straight, flat, round tips. Length: 120mm



Cat. No.	Material	A mm	B mm	Pkg.
78317-2AX	AntiAcid/AntiMag SS	0.05	2	each

**III Style 3R**

Very sharp, reverse action with guide pin. Length: 120mm



Cat. No.	Material	A mm	B mm	Pkg.
78318-3R	Anti-Acid/Anti-Mag SS	0.10	0.20	each

**III Style 3X**

Reverse action tweezers: straight, extra fine tips. Length: 120mm



Cat. No.	Material	A mm	B mm	Pkg.
78318-3X	AntiAcid/AntiMag SS	0.1	0.2	each

**III Style 4R**

Extra fine tips, reverse action with guide pin. Length: 110mm



Cat. No.	Material	A mm	B mm	Pkg.
78318-4R	Anti-Acid/Anti-Mag SS	0.11	0.16	each

**III Style 4X**

Reverse action tweezers: straight, extra fine tips. Length: 105mm



Cat. No.	Material	A mm	B mm	Pkg.
78319-4X	AntiAcid/AntiMag SS	0.1	0.1	each

**III Style 5AX**

Reverse action tweezers: straight, extra fine tips. Length: 110mm



Cat. No.	Material	A mm	B mm	Pkg.
78320-5AX	AntiAcid/AntiMag SS	0.1	0.2	each

**III Style 5TTHX**

Reverse action tweezers: anti capillary, extra fine tips. Length: 110mm



Cat. No.	Material	A mm	B mm	Pkg.
78325-17	AntiAcid/AntiMag SS	0.1	0.2	each

**III Style 5X**

Reverse action tweezers: straight, extra fine tips. Length: 110mm



Cat. No.	Material	A mm	B mm	Pkg.
78320-5X	AntiAcid/AntiMag SS	0.1	0.1	each
78520-5X	Superalloy AntiAcid/AntiMag	0.1	0.1	each
78320-5XGP	Gold Plating	0.1	0.1	each

**III Style 7X**

Reverse action tweezers: very fine, curved tips Length: 115mm



Cat. No.	Material	A mm	B mm	Pkg.
78325-7X	AntiAcid/AntiMag SS	0.2	0.2	each

**III Kit of Reverse Action Tweezers**

Kit of 5 Reverse action tweezers — Anti-Acid/Anti-Mag SS encased in top quality hard/foam wallet. Tweezers also available individually. Includes styles 2AX, 3X, 5X, 5AX, 7X.



Cat. No.	Description	Pkg.
78325-18	Tweezer Kit, Reverse Action, Stainless Steel	kit

EMS LINE OF TWEEZERS

Biology Tweezers

Made of superalloy (CX) or high-alloy stainless steel (DX), these biology tweezers are the perfect choice to be used under a microscope as the ultra-fine tips are ideal for handling extremely minute material and grids. The superior alloy materials resist extreme temperatures, chemicals and other harsh conditions.

TIP DIMENSION GUIDE:

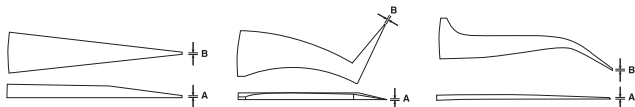

Superalloy CX Biological Tweezers

EMS is proud to introduce this new category of Swiss Made Tweezers. They are available in Superalloy with serrated grips and contain Nickel, Chromium, and Molybdenum.

- Anti-acid • Anti-magnetic • Serrated handles

III Style 3SG

Biology tweezers: straight, very sharp, fine tips. Length: 120mm



Cat. No.	Material	A mm	B mm	Pkg.
78325-3SA	Superalloy Anti-Acid/Anti-Mag serrated	0.04	0.08	each

III Style 4SG

Biology tweezers: straight, extra fine tips. Length: 110mm



Cat. No.	Material	A mm	B mm	Pkg.
78325-4SA	Superalloy Anti-Acid/Anti-Mag serrated	0.03	0.06	each

III Style 5SG

Biology tweezers: straight, extra fine tips. Length: 110mm



Cat. No.	Material	A mm	B mm	Pkg.
78325-5SA	Superalloy Anti-Acid/Anti-Mag serrated	0.02	0.05	each

III Style 7SG

Biology tweezers: very fine, curved tips. Length: 115mm



Cat. No.	Material	A mm	B mm	Pkg.
78325-7SA	Superalloy Anti-Acid/Anti-Mag serrated	0.03	0.07	each

Mini CX Biological Tweezers

These mini biology tweezers are the perfect choice for use under a microscope.

For our complete selection of mini tweezers, see page 9.

III Style M3E

Mini biology tweezers: straight, sharp, fine tips. Length: 80mm



Cat. No.	Material	A mm	B mm	Pkg.
78325-M3E	Superalloy AntiAcid/AntiMag	0.03	0.14	each

III Style M5E

Mini biology tweezers: straight, extra fine tips. Length: 80mm



Cat. No.	Material	A mm	B mm	Pkg.
78325-M5E	Superalloy AntiAcid/AntiMag	0.02	0.07	each

Highalloy DX Biological Tweezers

- Anti-acid • Anti-magnetic • Serrated handles

III Style 3

Biology tweezers: straight, very sharp, fine tips. Length: 120mm



Cat. No.	Material	A mm	B mm	Pkg.
78511-3	Highalloy AntiAcid/AntiMag SS	0.04	0.08	each

III Style 4

Biology tweezers: straight, extra fine tips. Length: 110mm



Cat. No.	Material	A mm	B mm	Pkg.
78512-4DX	Highalloy AntiAcid/AntiMag SS	0.03	0.06	each

III Style 5

Biology tweezers: straight, extra fine tips. Length: 110mm



Cat. No.	Material	A mm	B mm	Pkg.
78325-5DX	Highalloy AntiAcid/AntiMag SS	0.02	0.05	each

III Style 7

Biology tweezers: very fine, curved tips. Length: 115mm



Cat. No.	Material	A mm	B mm	Pkg.
78325-7DX	Highalloy AntiAcid/AntiMag SS	0.03	0.07	each

## Mini Tweezers

## EMS Anti-Acid/Anti-Magnetic Mini Tweezers

- Low carbon austenitic steel (Material number 1.4435, DIN X2CrNiMo18-14-3, AISI number 316L)
- Contains from 16.5 to 18.5 wt% chromium and has important quantities of nickel and molybdenum as additional alloying elements
- Good corrosion resistance to most chemicals, salts and acids

## TIP DIMENSION GUIDE:

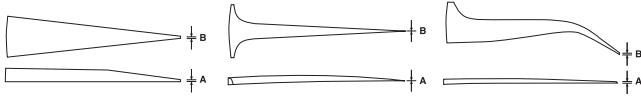

## III Style M00D

Mini tweezers with serrated handles and sharp, fine, line serrated tips. Length: 90mm



Cat. No.	Material	A mm	B mm	Pkg.
78325-M00D	Anti-Acid/Anti-Mag SS	0.20	0.20	each

## III Style M2

Mini tweezers with flat, sharp, fine tips. Length: 80mm



Cat. No.	Material	A mm	B mm	Pkg.
78325-M2	Anti-Acid/Anti-Mag SS	0.15	0.25	each

## III Style M2A

Mini tweezers with rounded, flat tips. Length: 70mm



Cat. No.	Material	A mm	B mm	Pkg.
78325-M2A	Anti-Acid/Anti-Mag SS	0.10	1.25	each

## III Style M3

Mini tweezers with rounded, flat tips. Length: 70mm



Cat. No.	Material	A mm	B mm	Pkg.
78325-M3	Anti-Acid/Anti-Mag SS	0.10	0.20	each

## III Style M4

Mini tweezers with sharp fine tips. Length: 70mm



Cat. No.	Material	A mm	B mm	Pkg.
78325-M4	Anti-Acid/Anti-Mag SS	0.05	0.15	each

## III Style M5

Mini tweezers with straight extra fine tips. Length: 80mm



Cat. No.	Material	A mm	B mm	Pkg.
78325-M5	Anti-Acid/Anti-Mag SS	0.08	0.13	each

## EMS High Precision Mini Tweezers

## III Style M3E.S

High precision mini tweezers with sharp fine tips, SS, superior finish. Length: 70mm



Cat. No.	Material	A mm	B mm	Pkg.
78325-M3ES	Stainless Type S	0.05	0.15	each

## III Style M5E.S

High precision mini tweezers with sharp fine tips, SS, superior finish. Length: 80mm



Cat. No.	Material	A mm	B mm	Pkg.
78325-M5ES	Stainless Type S	0.06	0.10	each

## EMS Swiss Line Mini Tweezers

- SA steel: acid-proof, stainless steel, 100% antimagnetic and resistant to HF and nitric acid.

## DIMENSION GUIDE:



## III Style 1M

Mini tweezers with rounded, flat tips. Length: 70mm



Cat. No.	M mm	N mm	P mm	Pkg.
7800-1M	8.00	1.50	42.00	each

## III Style 2AM

Mini tweezers with rounded, flat tips 2mm wide. Length: 70mm



Cat. No.	M mm	N mm	P mm	Pkg.
7800-2AM	8.00	1.50	22.00	each

## III Style 2M

Mini tweezers with sharp fine tips. Length: 70mm



Cat. No.	M mm	N mm	P mm	Pkg.
7800-2M	8.00	1.50	23.00	each

## III Style 3M

Edges on the outside rounded off. Length: 70mm



Cat. No.	M mm	N mm	P mm	Pkg.
7800-3M	8.00	1.50	42.00	each

EMS LINE OF TWEEZERS

Economy Tweezers

Handcrafted to perfect tip symmetry and balance, polished edges, superior no-scratch/antiglare satin finish

- Made of 304 Stainless Steel
- Inexpensive Tweezers may be beneficial in non-critical applications
- These tweezers are anti-acid/non-corrosive and anti-magnetic

DIMENSION GUIDE:

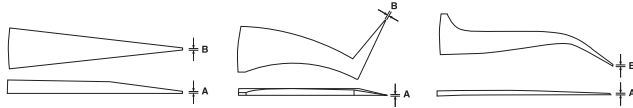

III Style 00

Stainless steel tweezers with strong, flat edges, thick tips. Length: 120mm



Cat. No.	Material	A mm	B mm	Pkg.
78326-40	Anti-Acid/Anti-Mag SS	0.40	0.25	each

III Style 1

Stainless steel tweezers with fine tips. Length: 125mm



Cat. No.	Material	A mm	B mm	Pkg.
78326-41	Anti-Acid/Anti-Mag SS	0.10	0.15	each

III Style 2

Stainless steel tweezers with sharp, fine tips. Length: 120mm



Cat. No.	Material	A mm	B mm	Pkg.
78326-42	Anti-Acid/Anti-Mag SS	0.10	0.15	each

III Style 2A

Stainless steel tweezers with flat, accurate, round tips. Length: 120mm



Cat. No.	Material	A mm	B mm	Pkg.
78326-43	Anti-Acid/Anti-Mag SS	0.20	2.20	each

III Style 3

Stainless steel tweezers with very sharp, fine tips. Length: 120mm



Cat. No.	Material	A mm	B mm	Pkg.
78326-44	Anti-Acid/Anti-Mag SS	0.15	0.20	each

III Style 3C

Stainless steel tweezers with very sharp, fine tips. Length: 110mm



Cat. No.	Material	A mm	B mm	Pkg.
78326-45	Anti-Acid/Anti-Mag SS	0.15	0.20	each

III Style 4

Stainless steel tweezers with fine tips. Length: 110mm



Cat. No.	Material	A mm	B mm	Pkg.
78326-46	Anti-Acid/Anti-Mag SS	0.10	0.10	each

III Style 5

Stainless steel tweezers with fine, sharp tips. Length: 110mm



Cat. No.	Material	A mm	B mm	Pkg.
78326-47	Anti-Acid/Anti-Mag SS	0.05	0.15	each

III Style 5A

Stainless steel tweezers with extra fine, sharp tips. Length: 120mm



Cat. No.	Material	A mm	B mm	Pkg.
78326-48	Anti-Acid/Anti-Mag SS	0.10	0.15	each

III Style 6

Stainless steel tweezers with angled, flat, fine tips. Length: 120mm



Cat. No.	Material	A mm	B mm	Pkg.
78326-49	Anti-Acid/Anti-Mag SS	0.10	0.20	each

III Style 7

Stainless steel tweezers with fine, curved tips. Length: 120mm



Cat. No.	Material	A mm	B mm	Pkg.
78326-50	Anti-Acid/Anti-Mag SS	0.15	0.10	each

III Style 7A

Stainless steel tweezers with strong fine, curved tips. Length: 120mm



Cat. No.	Material	A mm	B mm	Pkg.
78326-51	Anti-Acid/Anti-Mag SS	0.15	0.25	each

EMS LINE OF TWEEZERS

Economy Tweezers

III Style AA

Stainless Boley tweezers with sharp, fine tips. Length: 130mm



Cat. No.	Material	A mm	B mm	Pkg.
78326-52	Anti-Acid/Anti-Mag SS	0.30	0.25	each

III Style AC

Stainless steel tweezers with serrated handles and strong tips. Length: 110mm



Cat. No.	Material	A mm	B mm	Pkg.
78326-53	Anti-Acid/Anti-Mag SS	0.15	0.35	each

III Style MM

Stainless Boley tweezers with thick, strong, pointed tips. Length: 125mm



Cat. No.	Material	A mm	B mm	Pkg.
78326-54	Anti-Acid/Anti-Mag SS	0.15	0.20	each

III Style SS

Stainless steel tweezers with fine, sharp tips. Length: 140mm



Cat. No.	Material	A mm	B mm	Pkg.
78326-55	Anti-Acid/Anti-Mag SS	0.15	0.20	each

III Kit of Economy Tweezers

Kit of 5 stainless steel tweezers. Includes styles 00, 2A, 3C, 5, and 7.



Catalog No.	Kit	Styles	Pkg.
K5-ECO.SA	Kit of 5	Styles 00, 2A, 3C, 5 and 7	each

Boley Tweezers

General purpose tweezers. All shanks are tapered and have beveled edges. The sharp points have received some finishing at the tips.

III Style AA

Anti-Acid/Anti-Mag SS - tips: sharp, fine. OAL: 130mm, 5", High Precision, General purpose straight fine tips.



Cat. No.	Description	Pkg.
78325-43	Boley Tweezers, Style AA	each

III Style MM

Anti-Acid/Anti-Mag SS - tips: straight, thick, strong, pointed. OAL: 125mm, General purpose strong fine tips.



Cat. No.	Material	Pkg.
78325-44	Boley Tweezers, Style MM	each

You may also need...

III Tweezer Holder

EMS EXCLUSIVE

Holds 6 tweezers. Keeps tips protected in an easy to reach position.

Cat. No.	Description	Qty.
72900	Tweezer Holder	each

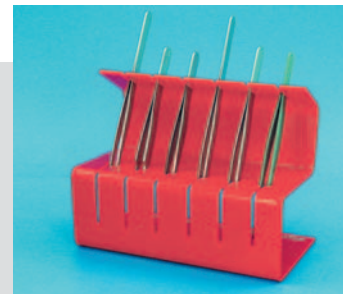

III Tweezers Protection Caps

These caps are in the shape of a tweezer tip and made from Polyethylene. Use to protect tweezers tips from damage.

Cat. No.	Description	Qty.
72904-12	Tweezers Protection Caps 12/pk.	



III EMS Tweezer Protection Box

Made from soft silicone; grooved properly to tightly hold all types of tweezers in place. The tip of the tweezer is always well protected from any damage. The silicone pad is held in a plastic box with a hinged lid that keeps the tweezers free from dust. Holds 7 tweezers.

**Overall measurements:** 6 1/8"(L)x4 3/8"(W)x1 3/8"(H);  
**Inside measurements:** 6"(L)x4"(W)x1 1/4"(H)

Cat. No.	Description	Qty.
72902	Tweezer Protection Box	each

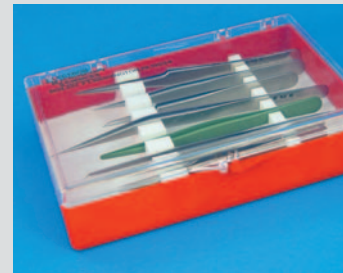

III O-Rings for Tweezers

This Neoprene O-Ring is used as a simple clamping device for tweezers.

Cat. No.	Description	Qty.
72903-12	Tweezers O-Rings	12/pk.



EMS LINE OF TWEEZERS

Premium Economy Tweezers

Handcrafted to perfect tip symmetry and balance, polished edges, superior no-scratch/antiglare satin finish

- Made of 316 Stainless Steel
- Inexpensive Tweezers may be beneficial in non-critical applications
- These tweezers are anti-acid/non-corrosive and anti-magnetic

DIMENSION GUIDE:

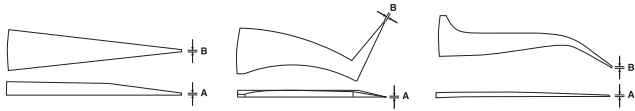

III Style 00

Straight, strong, thick tips. Length: 120mm



Cat. No.	Material	A mm	B mm	Pkg.
78326-70	Anti-Acid/Anti-Mag SA	0.40	0.25	each

III Style 00D

Straight, strong, thick tips. Length: 120mm



Cat. No.	Material	A mm	B mm	Pkg.
78326-71	Anti-Acid/Anti-Mag SA	0.40	0.25	each

III Style 0C9

Straight, strong, thick tips. Length: 90mm



Cat. No.	Material	A mm	B mm	Pkg.
78326-72	Anti-Acid/Anti-Mag SA	0.10	0.15	each

III Style 1

Straight, fine tips. Length: 125mm



Cat. No.	Material	A mm	B mm	Pkg.
78326-73	Anti-Acid/Anti-Mag SA	0.10	0.15	each

III Style 2

Straight, sharp, fine tips. Length: 120mm



Cat. No.	Material	A mm	B mm	Pkg.
78326-74	Anti-Acid/Anti-Mag SA	0.05	0.15	each

III Style 2A

Straight, flat, round tips. Length: 120mm



Cat. No.	Material	A mm	B mm	Pkg.
78326-75	Anti-Acid/Anti-Mag SA	0.20	2.20	each

III Style 3

Straight, very sharp, fine tips. Length: 120mm



Cat. No.	Material	A mm	B mm	Pkg.
78326-76	Anti-Acid/Anti-Mag SA	0.15	0.20	each

III Style 3C

Shorter than style 3. Straight, very sharp, fine tips. Length: 110mm



Cat. No.	Material	A mm	B mm	Pkg.
78326-77	Anti-Acid/Anti-Mag SA	0.15	0.20	each

III Style 4

Straight, fine tips. Length: 110mm



Cat. No.	Material	A mm	B mm	Pkg.
78326-78	Anti-Acid/Anti-Mag SA	0.10	0.10	each

III Style 5

Straight, fine, sharp tips. Length: 110mm



Cat. No.	Material	A mm	B mm	Pkg.
78326-79	Anti-Acid/Anti-Mag SA	0.05	0.15	each

III Style 5A

Straight, extra fine, sharp tips. Length: 120mm



Cat. No.	Material	A mm	B mm	Pkg.
78326-80	Anti-Acid/Anti-Mag SA	0.10	0.15	each

III Style 6

Angled, flat, fine tips. Length: 120mm



Cat. No.	Material	A mm	B mm	Pkg.
78326-81	Anti-Acid/Anti-Mag SA	0.10	0.20	each

III Style 7

Fine, curved tips. Length: 120mm



Cat. No.	Material	A mm	B mm	Pkg.
78326-82	Anti-Acid/Anti-Mag SA	0.15	0.10	each

## Premium Economy Tweezers (continued)

**III Style 7A**

Fine, curved tips. Length: 120mm



Cat. No.	Material	A mm	B mm	Pkg.
78326-83	Anti-Acid/Anti-Mag SA	0.15	0.25	each

**III Style 7B**

Fine, curved tips. Length: 120mm



Cat. No.	Material	A mm	B mm	Pkg.
78326-84	Anti-Acid/Anti-Mag SA	0.15	0.25	each

**III Style AA.SA.6**

High precision boley tweezers - tips: straight, sharp, fine. Length: 130mm



Cat. No.	Material	A mm	B mm	Pkg.
78326-89	Anti-Acid/Anti-Mag SA	0.30	0.25	each

**III Style AC**

Straight, strong tips; Serrated handles. Length: 110mm



Cat. No.	Material	A mm	B mm	Pkg.
78326-85	Anti-Acid/Anti-Mag SA	0.15	0.35	each

**III Style MM**

Straight, thick, strong, pointed tips. Length: 125mm



Cat. No.	Material	A mm	B mm	Pkg.
78326-87	Anti-Acid/Anti-Mag SA	0.15	0.20	each

**III Style MM**

Straight, thick, strong, pointed tips. Length: 125mm



Cat. No.	Material	A mm	B mm	Pkg.
78326-88	Stainless Type S	0.15	0.205	each

**III Style SS**

Straight, fine, sharp tips. Length: 140mm



Cat. No.	Material	A mm	B mm	Pkg.
78326-86	Anti-Acid/Anti-Mag SA	0.15	0.20	each

## You may also need...

**III Tweezer Holder****EMS EXCLUSIVE**

Holds 6 tweezers. Keeps tips protected in an easy to reach position.

Cat. No.	Description	Qty.
72900	Tweezer Holder	each

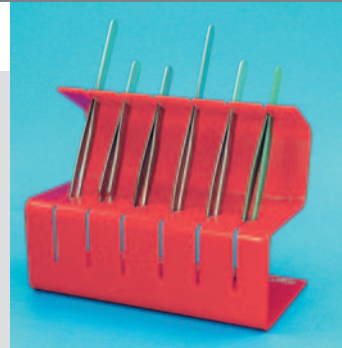
**III Tweezers Protection Caps**

These caps which are in the shape of the tweezer tip are made from Polyethylene and are used to protect the tweezers tips from damage.

Cat. No.	Description	Qty.
72904-12	Tweezers Protection Caps 12/pk.	

**III EMS Tweezer Protection Box**

Made from soft silicone; grooved properly to tightly hold all types of tweezers in place. The tip of the tweezer is always well protected from any damage. The silicone pad is held in a plastic box with a hinged lid that keeps the tweezers free from dust. Holds 7 tweezers.

**Overall measurements:** 6½"(L)x4½"(W)x1½"(H);  
**Inside measurements:** 6"(L)x4"(W)x1¼"(H)

Cat. No.	Description	Qty.
72902	Tweezer Protection Box	each

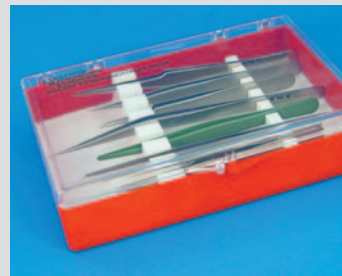
**III O-Rings for Tweezers**

This Neoprene O-Ring is used as a simple clamping device for tweezers.

Cat. No.	Description	Qty.
72903-12	Tweezers O-Rings	12/pk.

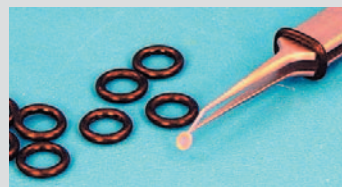
**III The Tweezer Repair Kit**

This repair kit allows you to straighten, resharpen, and repair your tweezers that have been damaged or have become dull. Instructions are included with the kit

**The kit includes:**

- 1 Sharpening stone
- Chain nose pliers
- Instrument Oil, 50 ml
- Ten O-rings



Cat. No.	Description	Qty.
72892-10	The Tweezer Repair Kit	kit



EMS LINE OF TWEEZERS

EMS Standard Tweezers

DIMENSION GUIDE:

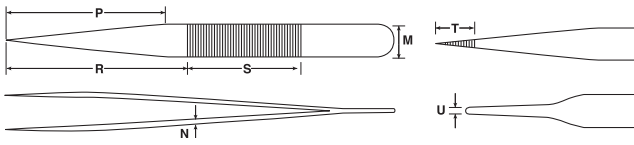

III Style 0

Ultra fine straight pointed precision tip. Length: 120mm



Catalog No.	M mm	N mm	P mm	Qty.
7801-0	10.00	1.50	33.00	each

III Style 00

Sturdy, strong, pointed classic tweezers made from the finest stainless steel. Tip Width: 0.5mm. Overall Length: 120mm



Catalog No.	M mm	N mm	P mm	Qty.
7801-00	10.00	2.50	46.00	each

III Style 1

Ultra fine straight pointed precision tip. Length: 120mm



Catalog No.	M mm	N mm	P mm	Qty.
7801-1	10.00	1.50	50.00	each

III Style 2

Strong, long, ultra fine pointed tips. Length: 115mm



Catalog No.	M mm	N mm	P mm	Qty.
7801-2	10.00	1.50	34.00	each

III Style 2A

Round tip. Tip Width: 2.0mm. Length: 120mm



Catalog No.	M mm	N mm	P mm	Qty.
7801-2A	10.00	1.50	35.00	each

III Style 3

Ultra fine straight pointed precision tip; edges on the outside rounded off. Length: 120mm



Catalog No.	M mm	N mm	P mm	Qty.
7801-3	10.00	1.50	50.00	each

III Style 3C

Ultra fine straight pointed precision tip. Length: 110mm



Catalog No.	M mm	N mm	P mm	Qty.
7801-3C	9.00	1.50	43.00	each

III Style 4

Very thin, stronger than style 5, ultra fine pointed tips. Length: 110mm



Catalog No.	M mm	N mm	P mm	Qty.
7801-4	10.00	1.50	30.00	each

III Style 4A

Ultra fine pointed tips. Length: 110mm



Catalog No.	M mm	N mm	P mm	Qty.
7801-4A	9.50	1.50	31.00	each

III Style 5

Super thin, ultra fine pointed tips. Length: 110mm



Catalog No.	M mm	N mm	P mm	Qty.
7801-5	10.00	1.50	30.00	each

III Style 5A

Oblique, ultra fine pointed tips. Length: 115mm



Catalog No.	M mm	N mm	P mm	Qty.
7801-5A	10.00	1.50	34.00	each

III Style 5AR

Ultra fine pointed tips. Length: 115mm



Catalog No.	M mm	N mm	P mm	Qty.
7801-5AR	10.00	1.50	34.00	each

III Style 7

Curved and thin, ultra fine pointed tips. Length: 115mm



Catalog No.	M mm	N mm	P mm	Qty.
7801-7	11.00	1.50	34.00	each

III Style 35A

Round tip. Length: 120mm



Catalog No.	M mm	N mm	P mm	Qty.
7801-35A	10.00	1.50	60.00	each

III Style 35B

Round tip. Length: 118mm



Catalog No.	M mm	N mm	P mm	Qty.
7801-35B	10.00	1.50	50.00	each

EMS Standard Tweezers (continued)

**III Style 49D**

Delrin tips. Temperature resistant up to 115°C. Very soft material, non-scratching, nicking or marring. Excellent for use in biotech applications.



Catalog No.	Description	OAL mm	M mm	N mm	P mm	Qty.
7801-49D	Style 49D	125	10.00	1.50	60.00	each

**III Style 258Peek**

Tweezer tip with 30% carbon fibers. ESD safe, anti-magnetic, anti acid. High resistance to abrasion. Temperature resistance up to 250°C (short exposure up to 300°C). Can be sterilized at 143°C. Often used in the disc drive industry and for ceramic parts.



*For more Tweezers with synthetic tips, see pages 41–49.*

Catalog No.	Description	OAL mm	M mm	N mm	P mm	R mm	S mm	Qty.
7801-258Peek	Style 258Peek	125	10.00	1.50	65.00	38.00	35.00	each

**III Style 321**

Round tip.



Catalog No.	Description	OAL mm	M mm	N mm	P mm	R mm	S mm	Qty.
7801-321	Style 321	118	9.00	1.50	47.00	44.00	35.00	each

**III Style 321R**

Comfortable soldering tweezers, insertion/extraction tweezers and anti-wicking tweezers.



Catalog No.	Description	OAL mm	M mm	N mm	P mm	R mm	U mm	Qty.
7802-321R	Style 321R	125	8.00	1.50	—	60.00	3.50	each

**III Style 615**

General use tweezers with alignment pin. Tips grooved inside.



Catalog No.	Description	OAL mm	M mm	N mm	P mm	Qty.
7801-615	Style 615	155	8.00	2.00	—	each

**III Style AA**

Ultra fine straight pointed precision tip.



Catalog No.	Description	OAL mm	M mm	N mm	P mm	Qty.
7801-AA	Style AA	125	11.00	1.50	60.00	each

**III Style F**

Round tip. Tip Width: 2.5mm



Catalog No.	Description	OAL mm	M mm	N mm	P mm	Qty.
7801-F	Style F	120	10.00	1.50	33.00	each

**III Style OA**

Comfortable soldering tweezers, insertion/extraction tweezers and anti-wicking tweezers. Length: 160mm



Catalog No.	M mm	N mm	P mm	T mm	U mm	Qty.
7802-OA	10.00	2.00	83.00	12.00	2.00	each

**III Style OR**

Reverse action. Length: 117mm



Catalog No.	M mm	N mm	P mm	Qty.
7801-OR	10.00	1.50	44.00	each

**III Style SS**

Extra long, slim, ultra fine straight pointed precision tip.



Catalog No.	Description	OAL mm	M mm	N mm	P mm	Qty.
7801-SS	Style SS	135	8.00	1.50	83.00	each

EMS LINE OF TWEEZERS

High-End Medical Tweezers

EMS is proud to introduce this new category of Tweezers. They are all handcrafted to perfect tip symmetry and balance and the surface has an electropolish finish. With high precision fine tips and Dot Serrated handles for a perfect grip. All of these tweezers can be sterilized and they are all made from Inox.

III Style 1LUSO.S

			<b>OAL</b>		<b>B</b>		<b>C</b>		
<b>Cat. No.</b>	[mm]	[inch]	[mm]	[inch]	[mm]	[inch]	[mm]	[inch]	<b>Qty.</b>
78920-01	120	4.7244	0.20	0.0079	0.12	0.0047			each



III Style 2LUSO.S

			<b>OAL</b>		<b>B</b>		<b>C</b>		
<b>Cat. No.</b>	[mm]	[inch]	[mm]	[inch]	[mm]	[inch]	[mm]	[inch]	<b>Qty.</b>
78920-02	120	4.7244	0.34	0.0134	0.14	0.0055			each



III Style 3LUSO.S

			<b>OAL</b>		<b>B</b>		<b>C</b>		
<b>Cat. No.</b>	[mm]	[inch]	[mm]	[inch]	[mm]	[inch]	[mm]	[inch]	<b>Qty.</b>
78920-03	120	4.7244	0.17	0.0067	0.10	0.0039			each

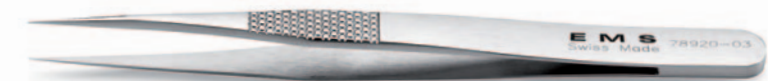

III Style 4LUSO.S

			<b>OAL</b>		<b>B</b>		<b>C</b>		
<b>Cat. No.</b>	[mm]	[inch]	[mm]	[inch]	[mm]	[inch]	[mm]	[inch]	<b>Qty.</b>
78920-04	110	4.3307	0.13	0.0051	0.08	0.0031			each



III Style 7LUSO.S

			<b>OAL</b>		<b>B</b>		<b>C</b>		
<b>Cat. No.</b>	[mm]	[inch]	[mm]	[inch]	[mm]	[inch]	[mm]	[inch]	<b>Qty.</b>
78920-08	115	4.5275	0.17	0.0067	0.10	0.0039			each

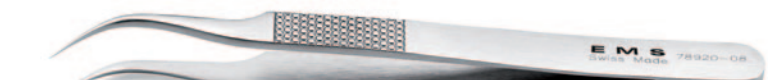

III Style 27LUSO.S

			<b>OAL</b>		<b>B</b>		<b>C</b>		
<b>Cat. No.</b>	[mm]	[inch]	[mm]	[inch]	[mm]	[inch]	[mm]	[inch]	<b>Qty.</b>
78920-09	135	5.3150	0.17	0.0067	0.10	0.0039			each



You may also need...Surgical Tools

Did you know that we have Surgical Tools as well? Visit [www.emsdiasum.com](http://www.emsdiasum.com) for Retractors, Forceps, and Scissors.



## Gold Plated Tweezers

EMS Gold Coated Tweezers are finely crafted, high precision tweezers made from anti-acidic, non-magnetic stainless steel, plated with 2 microns of pure 24-carat gold. Gold plating resists chemical corrosion, oxidation and is an excellent conductor of electricity. These tweezers are autoclavable and conducive for use when working with microelectronics, TEM and immunogold staining, electro-chemistry and nanotechnology. Choose from a variety of styles, designed to meet your specific need.

### DIMENSION GUIDE:

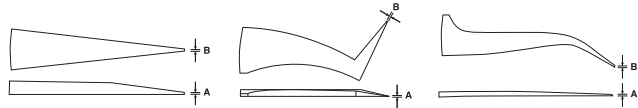

### III Style 1

Strong, Straight, Fine Tips. Length: 120mm



Cat. No.	Material	A mm	B mm	Pkg.
78750-01	Gold Plated Anti-Acid/Anti-Mag SS	0.11	0.14	each

### III Style 2A

Flat, Round Tips. Length: 120mm



Cat. No.	Material	A mm	B mm	Pkg.
78750-02	Gold Plated Anti-Acid/Anti-Mag SS	0.11	0.15	each

### III Style 3

Straight, High Precision. Length: 120mm



Cat. No.	Material	A mm	B mm	Pkg.
78750-04	Gold Plated Anti-Acid/Anti-Mag SS	0.11	0.15	each

### III Style 3CB

Fine points bent at 45°, High Precision. Length: 109mm



Cat. No.	Material	A mm	B mm	Pkg.
78750-03	Gold Plated Anti-Acid/Anti-Mag SS	0.11	0.15	each

### III Style 4

Straight, Fine Point, High Precision. Length: 110mm



Cat. No.	Material	A mm	B mm	Pkg.
78750-05	Gold Plated Anti-Acid/Anti-Mag SS	0.11	0.15	each

### III Style 5

High precision tweezers with sharp, fine tips. Length: 110mm



Cat. No.	Material	A mm	B mm	Pkg.
78750-07	Gold Plated Anti-Acid/Anti-Mag SS	0.06	0.10	each

### III Style 5B

Extra Fine points bent at 45°, High Precision. Length: 110mm



Cat. No.	Material	A mm	B mm	Pkg.
78750-06	Gold Plated Anti-Acid/Anti-Mag SS	10.06	0.10	each

### III Style 5TTH

Anti Capillary, Extra Fine Point, High Precision. Length: 110mm



Cat. No.	Material	A mm	B mm	Pkg.
78750-08	Gold Plated Anti-Acid/Anti-Mag SS	0.07	0.02	each

### III Style 7

Curved, Fine Point, High Precision. Length: 120mm



Cat. No.	Material	A mm	B mm	Pkg.
78750-09	Gold Plated Anti-Acid/Anti-Mag SS	0.09	0.16	each

### III Style 5X

Reversed, Self Closing, Fine Point, High Precision. Length: 110mm



Cat. No.	Material	A mm	B mm	Pkg.
78750-10	Gold Plated Anti-Acid/Anti-Mag SS	0.1	0.1	each

### III Style 7X

Reverse, Curved, Self Closing, Fine Point, High Precision. Length: 115mm



Cat. No.	Material	A mm	B mm	Pkg.
78750-11	Gold Plated Anti-Acid/Anti-Mag SS	0.2	0.2	each

### III Style 5TTHX

Reverse, Anti Capillary, Fine Point, High Precision. Length: 110mm



Cat. No.	Material	A mm	B mm	Pkg.
78750-12	Gold Plated Anti-Acid/Anti-Mag SS	0.1	0.2	each

EMS LINE OF TWEEZERS

ESD Diamond Coated Tweezers

EMS High Precision DLC Tweezers feature tips covered in a pure diamond film grown directly on the exposed metallic substrate via an innovative plasma-assisted deposition technique. It is not an adhesive-bonded diamond powder. The coating is comprised of carbon clusters which develop a crystalline structure and properties similar to a natural diamond. This procedure leaves the coating hydrogen free. These tweezers perform well in demanding environments and when working with hard samples or biological materials. Ideal for use in clean rooms. Tips stand up to repeated use. The body of the tweezer is non-magnetic, low-carbon stainless steel.

- High hardness (up to 90 GPa)
- No particulate shedding/contamination of the sample
- Bio-compatible (maintain cell integrity, no inflammatory response)
- Black-colored coating on tips only
- Low coating thickness (2μ) = High Elasticity
- Chemically inert up to 350°C / 662°F
- ESD safe, surface resistance of 106 Ohms
- Very clean with extremely high-wear and abrasion-resistant tips

III Style 0

ESD diamond coated tweezers:  
straight, fine tips



Cat. No.	Style	Material	Finish	Serration	OAL mm	A mm	B mm	ESD Safe	Pkg.
78752-09	Style 0	AntiAcid/AntiMag SS	Diamond Coated tips	-	120	0.1	0.15	Yes	each

III Style 00

ESD diamond coated tweezers:  
straight, strong, thick tips



Cat. No.	Style	Material	Finish	Serration	OAL mm	A mm	B mm	ESD Safe	Pkg.
78752-01	Style 00	AntiAcid/AntiMag SS	Diamond Coated tips	-	120	0.5	0.9	Yes	each

III Style 1

ESD diamond coated tweezers:  
straight, fine tips

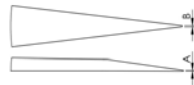

Cat. No.	Style	Material	Finish	Serration	OAL mm	A mm	B mm	ESD Safe	Pkg.
78752-13	Style 1	AntiAcid/AntiMag SS	Diamond Coated tips	-	120	0.1	0.15	Yes	each

III Style 2

ESD diamond coated tweezers:  
straight, sharp, fine tips



Cat. No.	Style	Material	Finish	Serration	OAL mm	A mm	B mm	ESD Safe	Pkg.
78325-12	Style 2	AntiAcid/AntiMag SS	Diamond Coated tips	-	120	0.05	0.15	Yes	each

III Style 2A

ESD diamond coated tweezers:  
straight, flat, round tips



Cat. No.	Style	Material	Finish	Serration	OAL mm	A mm	B mm	ESD Safe	Pkg.
2A.SA.DC	Style 2A	AntiAcid/AntiMag SS	Diamond Coated tips	-	120	0.05	1.65	Yes	each

III Style 2AB

ESD diamond coated tweezers: flat,  
round, curved tips



Cat. No.	Style	Material	Finish	Serration	OAL mm	A mm	B mm	ESD Safe	Pkg.
78325-13	Style 2AB	AntiAcid/AntiMag SS	Diamond Coated tips	-	120	0.11	1.5	Yes	each

III Style 3

ESD diamond coated tweezers:  
straight, very sharp, fine



Cat. No.	Style	Material	Finish	Serration	OAL mm	A mm	B mm	ESD Safe	Pkg.
78752-05	Style 3	AntiAcid/AntiMag SS	Diamond Coated tips	-	120	0.1	0.15	Yes	each

III Style 3C

ESD diamond coated tweezers:  
straight, very sharp, fine



Cat. No.	Style	Material	Finish	Serration	OAL mm	A mm	B mm	ESD Safe	Pkg.
78752-06	Style 3C	AntiAcid/AntiMag SS	Diamond Coated tips	-	110	0.10	0.20	Yes	each

## ESD Diamond Coated Tweezers (continued)

## III Style 4

ESD diamond coated tweezers:  
straight, extra fine tips

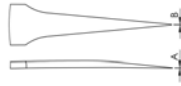

Cat. No.	Style	Material	Finish	Serration	OAL mm	A mm	B mm	ESD Safe	Pkg.
78325-4DC	Style 4	AntiAcid/AntiMag SS	Diamond Coated tips	-	110	0.1	0.1	Yes	each

## III Style 5

ESD diamond coated tweezers:  
straight, extra fine, sharp



Cat. No.	Style	Material	Finish	Serration	OAL mm	A mm	B mm	ESD Safe	Pkg.
78752-08	Style 5	AntiAcid/AntiMag SS	Diamond Coated tips	-	110	0.06	0.1	Yes	each

## III Style 5B

ESD diamond coated tweezers:  
straight, fine or extra fine, sharp

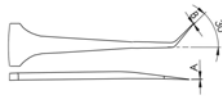

Cat. No.	Style	Material	Finish	Serration	OAL mm	A mm	B mm	ESD Safe	Pkg.
78752-10	Style 5B	AntiAcid/AntiMag SS	Diamond Coated tips, fine	-	110	0.07	0.12	Yes	each
72385-5BSA	Style 5B	AntiAcid/AntiMag SS	Diamond Coated tips, extra fine	-	110	0.06	0.1	Yes	each

## III Style 7

ESD diamond coated tweezers:  
very fine, curved tips

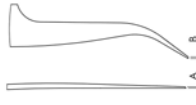

Cat. No.	Style	Material	Finish	Serration	OAL mm	A mm	B mm	ESD Safe	Pkg.
78752-11	Style 7	AntiAcid/AntiMag SS	Diamond Coated tips	-	120	0.09	0.16	Yes	each

## III Style 35A

ESD diamond coated tweezers - Serrated  
handles: smooth and flat surface



Cat. No.	Style	Material	Finish	Serration	OAL mm	A mm	B mm	ESD Safe	Pkg.
78752-16	Style 35A	AntiAcid/AntiMag SS	Diamond Coated tips	Serrated handles	120	0.15	7	Yes	each

## III Style 51S

ESD diamond coated tweezers - tips: bent  
for max visibility, extra fine, superior finish.



Cat. No.	Style	Material	Finish	Serration	OAL mm	A mm	B mm	ESD Safe	Pkg.
78752-51SSA	Style 51S	AntiAcid/AntiMag SS	Diamond Coated tips	-	115	0.08	0.15	Yes	each

## III Style 65A

ESD diamond coated tweezers:  
very fine, bent tips



Cat. No.	Style	Material	Finish	Serration	OAL mm	A mm	B mm	ESD Safe	Pkg.
78752-12	Style 65A	AntiAcid/AntiMag SS	Diamond Coated tips	-	140	0.07	0.15	Yes	each

## III Style SS

ESD diamond coated tweezers:  
straight, extra fine, very sharp tips



Cat. No.	Style	Material	Finish	Serration	OAL mm	A mm	B mm	ESD Safe	Pkg.
78325-DC6	Style SS	AntiAcid/AntiMag SS	Diamond Coated tips	-	150	0.12	0.12	Yes	each
78325-SS	Style SS	AntiAcid/AntiMag SS	Diamond Coated tips	-	140	0.09	0.12	Yes	each

## III Kit of ESD Diamond Coated Tweezers

For fine and precision work, this set includes one each of: Style 1 (#78752-13), style 2A (#78752-03), style 3C (#78752-06), Style 5 (#78752-08), and style 7 (#78752-11).

Cat. No.	Description	Pkg.
78752-14	EMS DLC Tweezers Set	5/set



# EMS LINE OF TWEEZERS

## ESD Rubber Tweezers

Soft ESD safe ergonomic cushion grips (resistivity 10E9 Ohm) provide enhanced operator comfort and reduced finger stress when handling ESD sensitive components or small static items.

### III Style 00

ESD rubber grip tweezers: straight, strong, thick tips



Cat. No.	Style	Material	Finish	OAL mm	A mm	B mm	ESD Safe	Pkg.
78390-00	Style 00	AntiAcid/AntiMag SS	ESD Rubber	120	0.5	0.90	Yes	each

### III Style 2A

ESD rubber grip tweezers: straight, flat, round tips



Cat. No.	Style	Material	Finish	OAL mm	A mm	B mm	ESD Safe	Pkg.
78392-2A	Style 2A	AntiAcid/AntiMag SS	ESD Rubber	125	0.07	1.7	Yes	each

### III Style 2AB

ESD rubber grip tweezers: flat, round, curved tips



Cat. No.	Style	Material	Finish	OAL mm	A mm	B mm	ESD Safe	Pkg.
78325-14	Style 2AB	AntiAcid/AntiMag SS	ESD Rubber	120	0.11	1.5	Yes	each

### III Style 3

ESD rubber grip tweezers: straight, very sharp, fine tips



Cat. No.	Style	Material	Finish	OAL mm	A mm	B mm	ESD Safe	Pkg.
78393-3	Style 3	AntiAcid/AntiMag SS	ESD Rubber	125	0.09	0.16	Yes	each

### III Style 3C

ESD rubber grip tweezers: straight, sharp, fine tips



Cat. No.	Style	Material	Finish	OAL mm	A mm	B mm	ESD Safe	Pkg.
78393-3C	Style 3C	AntiAcid/AntiMag SS	ESD Rubber	110	0.09	0.20	Yes	each

### III Style 4

ESD rubber grip tweezers: straight, extra fine tips



Cat. No.	Style	Material	Finish	OAL mm	A mm	B mm	ESD Safe	Pkg.
78325-4DR	Style 4	AntiAcid/AntiMag SS	ESD Rubber	110	0.09	0.11	Yes	each

### III Style 5

ESD rubber grip tweezers: straight, extra fine tips



Cat. No.	Style	Material	Finish	OAL mm	A mm	B mm	ESD Safe	Pkg.
78395-5	Style 5	AntiAcid/AntiMag SS	ESD Rubber	110	0.06	0.10	Yes	each

### III Style 5A

ESD rubber grip tweezers: straight, extra fine tips



Cat. No.	Style	Material	Finish	OAL mm	A mm	B mm	ESD Safe	Pkg.
78325-5A	Style 5A	AntiAcid/AntiMag SS	ESD Rubber	115	0.08	0.12	Yes	each

## ESD Rubber Tweezers (continued)

## III Style 5C

ESD rubber grip tweezers: curved, bent, ultra fine tips

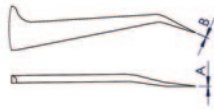

Cat. No.	Style	Material	Finish	OAL mm	A mm	B mm	ESD Safe	Pkg.
78325-5C	Style 5C	AntiAcid/AntiMag SS	ESD Rubber	115	0.10	0.15	Yes	each

## III Style 51S

ESD rubber grip tweezers: bent, extra fine tips



Cat. No.	Style	Material	Finish	OAL mm	A mm	B mm	ESD Safe	Pkg.
78325-16	Style 51S	AntiAcid/AntiMag SS	ESD Rubber	115	0.04	0.12	Yes	each

## III Style 7

ESD rubber grip tweezers: very fine tips, curved



Cat. No.	Style	Material	Finish	OAL mm	A mm	B mm	ESD Safe	Pkg.
78397-7	Style 7	AntiAcid/AntiMag SS	ESD Rubber	120	0.09	0.16	Yes	each

## III Style 14A

ESD rubber grip cutting tweezers: cutting, predominantly angled blades

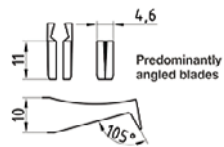

Cat. No.	Style	Material	Finish	OAL mm	A mm	B mm	ESD Safe	Pkg.
78325-07	Style 14A	Carbon Steel	ESD Rubber	115	4.6	11	Yes	each

## III Style 14AGW

ESD rubber grip cutting tweezers: cutting, predominantly angled blades

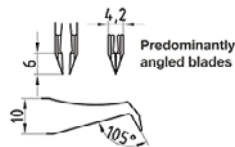

Cat. No.	Style	Material	Finish	OAL mm	A mm	B mm	ESD Safe	Pkg.
78325-08	Style 14AGW	Carbon Steel	ESD Rubber	115	4.2	6	Yes	each

## III Style 15A

ESD rubber grip cutting tweezers: cutting, angled blades

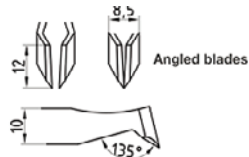

Cat. No.	Style	Material	Finish	OAL mm	A mm	B mm	ESD Safe	Pkg.
78325-09	Style 15A	Carbon Steel	ESD Rubber	120	8.5	12	Yes	each

## III Style 15AGW

ESD rubber grip cutting tweezers: cutting, predominantly angled blades

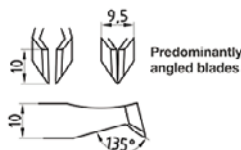

Cat. No.	Style	Material	Finish	OAL mm	A mm	B mm	ESD Safe	Pkg.
78325-10	Style 15AGW	Carbon Steel	ESD Rubber	115	9.5	10	Yes	each

## III Style AA

ESD rubber grip boley tweezers: straight, sharp, fine tips



Cat. No.	Style	Material	Finish	OAL mm	A mm	B mm	ESD Safe	Pkg.
78325-AA	Style AA	AntiAcid/AntiMag SS	ESD Rubber	130	0.3	0.25	Yes	each



EMS LINE OF TWEEZERS

ESD Epoxy Coated Tweezers

Coating Type NE

This conductive epoxy coating is essentially comprised of polyester and epoxy resins, plus the electrically conductive additives.

**Mechanical properties:** Impact resistant surface with excellent flow; good elasticity

**Heat resistance:** It can operate continuously at temperatures up to 120°C

**Unique electrical properties:** This coating provides an ESD Safe coating with surface resistance of  $10^5 - 10^6$

**Chemical resistance:** Good resistance to many diluted acids and alkalis. Contact with organic solvents is possible conditionally and for short term. Resistance should be investigated for the case in question.

Anti-magnetic anti-acid stainless steel (SA)

- Low carbon austenitic steel (Material number 1.4435, DIN X2CrNiMo18-14-3, AISI number 316L)
- Contains from 16.5 to 18.5 wt% chromium and has important quantities of nickel and molybdenum as additional alloying elements
- Non-magnetizable
- Good corrosion resistance to most chemicals, salts and acids
- Generally used where corrosion resistance and toughness are primary requirements
- Typical applications include tweezers for the electronic industry, watch-makers, jewelers and laboratory and medical applications in moderately aggressive chemical environments

Style SM103

ESD epoxy coated tweezers with handling, positioning at 45° angle. Length: 120mm



Cat. No.	Material	A mm	B mm	Pkg.
SM103.SA.NE	Anti-Acid/Anti-Mag SS	0.30	1.60	each

Style SM104

ESD epoxy coated tweezers with handling, positioning sot packages, monolithic chip capacitors. Length: 120mm



Cat. No.	Material	A mm	B mm	Pkg.
SM104.SA.NE	Anti-Acid/Anti-Mag SS	0.35	1.70	each

Style SM108

ESD epoxy coated tweezers with positioning, soldering 1mm wide components. Length: 120mm



Cat. No.	Material	A mm	B mm	Pkg.
SM108.SA.NE	Anti-Acid/Anti-Mag SS	0.30	1.50	each

Style 00

ESD epoxy coated tweezers with strong, thick tips. Length: 120mm



Cat. No.	Material	A mm	B mm	Pkg.
00.SA.NE	Anti-Acid/Anti-Mag SS,	0.40	0.25	each

Style 1

ESD epoxy coated tweezers with fine tips. Length: 125mm



Cat. No.	Material	A mm	B mm	Pkg.
1.SA.NE	Anti-Acid/Anti-Mag SS	0.10	0.15	each

Style 2A

ESD epoxy coated tweezers with flat, accurate, round tips. Length: 125mm



Cat. No.	Material	A mm	B mm	Pkg.
2A.SA.NE	Anti-Acid/Anti-Mag SS	0.20	2.20	each

Style 3

ESD epoxy coated tweezers with very sharp, fine tips. Length: 120mm



Cat. No.	Material	A mm	B mm	Pkg.
3.SA.NE	Anti-Acid/Anti-Mag SS	0.15	0.20	each

Style 3C

ESD epoxy coated tweezers with very sharp, fine tips. Length: 110mm



Cat. No.	Material	A mm	B mm	Pkg.
3C.SA.NE	Anti-Acid/Anti-Mag SS	0.15	0.10	each

Style 4

ESD epoxy coated tweezers with fine tips. Length: 110mm



Cat. No.	Material	A mm	B mm	Pkg.
4.SA.NE	Anti-Acid/Anti-Mag SS	0.10	0.10	each

Style 5

ESD epoxy coated tweezers with fine, sharp tips. Length: 110mm



Cat. No.	Material	A mm	B mm	Pkg.
5.SA.NE	Anti-Acid/Anti-Mag SS	0.05	0.15	each

ESD Epoxy Coated Tweezers (continued)

III Style 7

ESD epoxy coated tweezers with fine, curved tips. Length: 120mm



Cat. No.	Material	A mm	B mm	Pkg.
7.SA.NE	Anti-Acid/Anti-Mag SS	0.15	0.10	each

III Style 775

ESD epoxy coated tweezers with bent, fine tips. Length: 155mm



Cat. No.	Material	A mm	B mm	Pkg.
775.SA.NE	Anti-Acid/Anti-Mag SS	0.20	0.35	each

III Style AA

ESD epoxy coated tweezers with sharp, fine tips. Length: 125mm



Cat. No.	Material	A mm	B mm	Pkg.
AA.SA.NE	Anti-Acid/Anti-Mag SS	0.30	0.25	each

III Kits of ESD Epoxy Coated Tweezers

ESD epoxy coated tweezers

Cat. No.	Kit	Styles	Pkg.
K3.SA.NE	Kit of 3	Styles 775, SM103, and SM104	each
K4F.SA.NE	Kit of 4	Styles SM103, SM108, 3, and 7A	each
K5F.SA.NE	Kit of 5	Styles SM103, SM108, 3, 5, and 7A	each
K6F.SA.NE	Kit of 6	Styles SM103, SM108, 3, 3C, 5, and 7A	each

CUTTING STYLES

III Style 54MW

ESD epoxy coated cutting tweezers, full body: cutting, predominantly angled blades. Length: 115mm

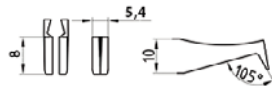

Cat. No.	Material	A mm	B mm	Pkg.
54MW.C.N	Carbon Steel	5.4	8	each

III Style 14AGW

ESD epoxy coated cutting tweezers: cutting, predominantly angled blades. Length: 115mm

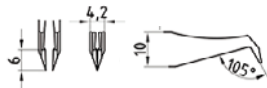

Cat. No.	Material	A mm	B mm	Pkg.
14AGW.C.NE	Carbon Steel	4.2	6	each

III Style 15A

ESD epoxy coated cutting tweezers: cutting, angled blades. Length: 120mm



Cat. No.	Material	A mm	B mm	Pkg.
15A.C.NE	Carbon Steel	8.5	12	each

III Style 15AGW

ESD epoxy coated cutting tweezers: cutting, predominantly angled blades. Length: 120mm

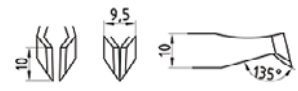

Cat. No.	Material	A mm	B mm	Pkg.
15AGW.C.NE	Carbon Steel	8.5	12	each

III Style 15AGHM

ESD epoxy coated cutting tweezers: cutting, Tungsten carbide insert, predominantly angled blades. Length: 120mm

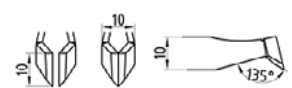

Cat. No.	Material	A mm	B mm	Pkg.
15AGHM.C.NE	Carbon Steel	8.5	12	each

III Style 15ARW

ESD epoxy coated cutting tweezers: cutting, predominantly angled blades. Length: 115mm

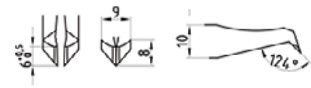

Cat. No.	Material	A mm	B mm	Pkg.
15ARW.C.NE	Carbon Steel	9	6	each

EMS LINE OF TWEEZERS

EMS Surface Mount & Optoelectronic Tweezers

Made from SA steel. They offer comfort and smooth handling. They are available in different tips and angles for specific jobs and they have a satin antiglare finish with an ergonomic design.

III Style SM2

Grooved handles. Tips: for positioning SOT packages, flat, squared, straight.

Cat. No.	Style	Material	OAL mm	A mm	B mm	Pkg.
78250-2	EMS Style SM2	Anti-Acid/Anti-Mag SS	120	0.30	1.50	each



III Style SM3

Tips: for positioning SOT packages, flat, squared, straight.

Cat. No.	Style	Material	OAL mm	A mm	B mm	Pkg.
78250-3	EMS Style SM3	Anti-Acid/Anti-Mag SS	120	0.40	1.35	each



III Style SM103

Same as SM105, but with bent tips.



Cat. No.	Style	Material	OAL mm	A mm	B mm	Pkg.
78250-50	EMS Style SM103	Anti-Acid/Anti-Mag SS	120	0.30	1.60	each



III Style SM104

Tips: for handling and positioning 3 lead SOT packages, monolithic chip capacitors, etc.



Cat. No.	Style	Material	OAL mm	A mm	B mm	Pkg.
78250-104	EMS Style SM104	Anti-Acid/Anti-Mag SS	120	0.35	1.70	each



III Style SM105 (formerly SMD40)

Tips are "T" shaped with 2mm flat gripping edges.



Cat. No.	Style	Material	OAL mm	A mm	B mm	Pkg.
78250-40	EMS Style SM105	Anti-Acid/Anti-Mag SS	120	0.30	1.55	each



III Style SM106

Tips: for positioning all SOT packages horizontally. With flat base, long, fine shaped, straight 4 mm long tips.



Cat. No.	Style	Material	OAL mm	A mm	B mm	Pkg.
78250-106	EMS Style SM106	Anti-Acid/Anti-Mag SS	120	0.25	3.80	each



III Style SM107 (formerly SMD90)

Tips: perfect flat tip 60 degree angle.measure 1.2mm wide. For positioning all flat devices.



Cat. No.	Style	Material	OAL mm	A mm	B mm	Pkg.
78250-90	EMS Style SM107	Anti-Acid/Anti-Mag SS	120	0.15	1.40	each



III Style SM108 (formerly SMD10)

Tips: cut on a 45° with a 1.5mm perfect inside gripping groove. Ideal for positioning and gripping 1mm diameter components.

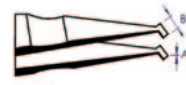

Cat. No.	Style	Material	OAL mm	A mm	B mm	Pkg.
78250-10	EMS Style SM108	Anti-Acid/Anti-Mag SS	120	0.30	1.50	each



III Style SM109

Tips: positioning, soldering 1mm wide components, 45°, no anti-crush feature, straight.



Cat. No.	Style	Material	OAL mm	A mm	B mm	Pkg.
78250-109	EMS Style SM109	Anti-Acid/Anti-Mag SS	120	0.25	2.00	each



## EMS Surface Mount &amp; Optoelectronic Tweezers (continued)

**III Style SM110 (formerly SMD100)**

Straight "T" shaped tips with a vertical groove inside for holding cylindrical objects up to 1 mm diameter. Absolutely perfect for holding and installing Omniprobe Tips (sold separately). Especially if you're using Cryo-lift out and have to install the tip with the rod already inserted into the SEM chamber. Forceps provide a firm grip and longitudinal stability reducing the chance of dropping the tip.



Cat. No.	Style	Material	OAL mm	A mm	B mm	Pkg.
78250-100	EMS Style SM110	Anti-Acid/Anti-Mag SS	120	0.45	2.00	each

**III Style SM111 (formerly SMD90)**

Same as SM 110, but the tips are bent on a 45 degree angle.



Cat. No.	Style	Material	OAL mm	A mm	B mm	Pkg.
78250-110	EMS Style SM111	Anti-Acid/Anti-Mag SS	115	0.50	1.50	each

**III Style SM112 (formerly SMD60)**

Tips are bent and cut on a 45 degree angle (2mm edge) and has a raised thickness inside for perfect control (anti-capillary).



Cat. No.	Style	Material	OAL mm	A mm	B mm	Pkg.
78250-60	EMS Style SM112	Anti-Acid/Anti-Mag SS	120	—	—	each

**III Style SM115 (formerly SMD70)**

Very fine rounded tips with groove inside on a 30° angle. Ideal for holding and positioning cylindrical devices (up to 1 mm diameter).



Cat. No.	Style	Material	OAL mm	A mm	B mm	Pkg.
78250-70	EMS Style SM115	Anti-Acid/Anti-Mag SS	120	0.60	0.85	each

**III Style SM116**

Tips: grooved, straight, for vertical positioning of cylindrical devices (up to 0.5 mm diam. or more).



Cat. No.	Style	Material	OAL mm	A mm	B mm	Pkg.
78250-116	EMS Style SM116	Anti-Acid/Anti-Mag SS	115	0.50	0.75	each

**III Style SM117**

Tips: For positioning SOT packages at 30° angle, flat, squared.



Cat. No.	Style	Material	OAL mm	A mm	B mm	Pkg.
78250-117	EMS Style SM117	Anti-Acid/Anti-Mag SS	120	0.40	1.50	each

**III EMS SMD Precision Tweezer Kit, SS**

Kit of 5 SMD tweezers - Anti-Acid/Anti-Mag SS. Includes styles: SM103, SM107, SM108, SM111, SM115. Top quality hard/foam wallet.



Cat. No.	Description	Pkg.
78250-K	EMS SMD Precision Tweezer Kit, SS	each

EMS LINE OF TWEEZERS

PTFE-Coated Tweezers

TIP DIMENSION GUIDE:



III Style 2A

High precision tweezers with flat, accurate, round tips. Provides a larger flat gripping surface for better handling of small objects without puncturing the membrane, wafer etc. Length: 120mm



Also available uncoated, see page 3.

Cat. No.	Material	A mm	B mm	Pkg.
72919-2ATe	Anti-Acid/Anti-Mag SS, "PTFE" Coating	0.07	1.70	each

III Style 2B

High precision tweezers with flat, accurate, round tips. Provides a larger flat gripping surface for better handling of small objects without puncturing the membrane, wafer etc. Length: 120mm



Also available uncoated, see page 3.

Cat. No.	Material	A mm	B mm	Pkg.
72919-2ABTe	Anti-Acid/Anti-Mag SS, "PVDF" Coating	0.11	1.50	each

III Style 3SA

Tips touching over 3mm (parallel tips), useful for handling tiny wires. Length: 120mm



Cat. No.	Material	A mm	B mm	Pkg.
78318-3SATe	Anti-Acid/Anti-Mag SS, "PTFE" Coating	0.1	0.15	each

III Style 5

Extra fine tips, superior finish. Length: 110mm



Also available uncoated, see page 4.

Cat. No.	Material	A mm	B mm	Pkg.
78320-5Te	"PTFE" Coating	0.06	0.10	each

III Style SS

High precision tweezers with flat, squared head, thin, strong tips. Length: 140mm

Also available uncoated, see page 6.

Cat. No.	Material	A mm	B mm	Pkg.
78325-SSSA	Anti-Acid/Anti-Mag SS, "PTFE" Coated	0.09	0.12	each

III Style 7

High precision tweezers with very fine, curved tips.. Length: 120mm



Also available uncoated, see page 5.

Cat. No.	Material	A mm	B mm	Pkg.
78322-7Te	"PTFE" Coating	0.09	0.16	each

III Style 321

Serrated handles. Tips: straight, rounded, flat. Length: 120 mm



Cat. No.	Material	A mm	B mm	Pkg.
78362-321	Anti-Acid/Anti-Mag SS, "PTFE" Coating	0.15	2.60	each

III Style 775

Serrated handles. Tips: straight, rounded, flat. Length: 120 mm



Also available epoxy-coated, see page 23.

Cat. No.	Material	A mm	B mm	Pkg.
78369-775	Anti-Acid/Anti-Mag SS, "PTFE" Coating	0.20	0.35	each

III Style AA

Boley tweezers, straight, sharp, fine tips. Length: 130mm



Cat. No.	Material	A mm	B mm	Pkg.
78325-AASA	Anti-Acid/Anti-Mag SS, "PTFE" Coated	0.15	0.35	each

III Style F

Tips: straight, flat, squared head, thin, strong, superior finish. Length: 120 mm



Cat. No.	Material	A mm	B mm	Pkg.
78325-FT	Anti-Acid/Anti-Mag SS, "PTFE" Coating	0.08	1.71	each



PTFE-Coated Tweezers (continued)

III Style 4WF

Wafer tweezers - serrated handles: handling 3", top fingers, stepped bottom paddle

Also available uncoated, see page 36.

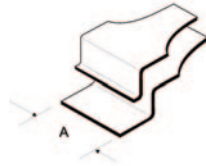

Cat. No.	Style	Material	Coating	Serration	OAL mm	A mm	Pkg.
4WF.SA.T	Style 4WF	AntiAcid/AntiMag SS	PTFE Coated full body	Serrated handles	125	12	each

III Style 6WF

Wafer tweezers - serrated handles: handling 6", top fingers, stepped bottom paddle

Also available uncoated, see page 37.

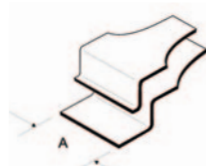

Cat. No.	Style	Material	Coating	Serration	OAL mm	A mm	Pkg.
6WF.SA.T	Style 6WF	AntiAcid/AntiMag SS	PTFE Coated full body	Serrated handles	130	20	each

III Style 45WF

Wafer tweezers - serrated handles: handling 5", top fingers, flat bottom paddle

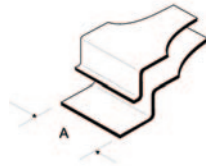

Cat. No.	Style	Material	Coating	Serration	OAL mm	A mm	Pkg.
45WF.SA.T	Style 45WF	AntiAcid/AntiMag SS	PTFE Coated full body	Serrated handles	130	16	each

You may also need... Smart Tweezers

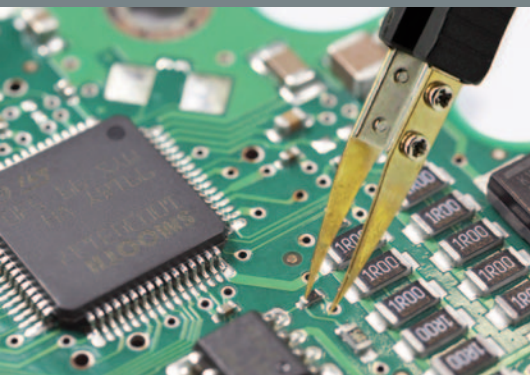

III Quick-Test Auto-Scanning Tweezers

Precise, non-magnetic tips reliably contact smallest SMD. The Quick Test tweezers gives users an easy way to sort and evaluate loose components and to perform on-board

measurements and debugging. Surface mount devices are usually tiny and without wire leads, making it much more difficult to test and identify SMD than conventional components. Precise tips, made of non-magnetic steel, are able to pick and reliably contact even the smallest SMD components, or take measurements from the device already mounted on a board. The probe can also be used to test conventional components with wire leads too short to insert into the test terminals.



Specifications

Resistance Range:

300/3K/30K/300K/3m/30M Ohms  
| Resolution: 0.1 Ohms

Capacitance Range: 3/30/300/nF

| 3uF/30uF/300uF/3mF/30mF  
| Resolution 1pF

Diode Check: Open Voltage: 2.8V

| Testing Current: 2mA

Continuity Check: When resistance is less than 30 ohms the buzzer will be activated

Weight 0.75 lb

- Measures AC/DC voltage, resistance, continuity & diode test
- Auto Scanning Mode/Auto range
- Testing pins gold plated to reduce resistance and prevent rust
- Uses Lithium battery CR2032, included
- Will automatically identify whether component is a resistor, capacitor or diode

Cat. No.	Description	Qty.
72907-01	Smart Tweezers, Straight Tips	each

EMS LINE OF TWEEZERS

ESD Foam Tweezers

Anti-magnetic precision tweezers with soft ESD ergonomic cushion grips (resistivity 10E8). Available with an ESD black Foam (DN) handle.

**PVS Foam**

- Very soft and elastic, good tear resistance
- Very good abrasion/wear resistance (improved life-time)
- Good chemical resistance (oils, grease, fuels, acids, detergents and soaps, alcohols )
- Electrically static dissipative, ESD-safe material
- Typical applications include ESD-safe handles, floor and work surface mats

**Anti-magnetic anti-acid stainless steel (SA)**

- Low carbon austenitic steel (Material number 1.4435, DIN X2CrNiMo18-14-3, AISI number 316L)
- Contains from 16.5 to 18.5 wt% chromium and important quantities of nickel and molybdenum as additional alloying elements
- Non-magnetizable
- Good corrosion resistance to most chemicals, salts and acids
- Generally used where corrosion resistance and toughness are primary requirements
- Typical applications include tweezers for the electronic industry, watch-makers, jewelers and laboratory and medical applications in moderately aggressive chemical environments

**III Style 00**

ESD foam grip tweezers with strong, thick tips

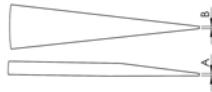

Catalog No.	Style	Material	Finish	OAL mm	A mm	B mm	Pkg.
00.SA.DN	Style 00	Anti-Acid/Anti-Mag SS	ESD Foam	120	-	-	each

**III Style 2A**

ESD foam grip tweezers with flat, accurate, round tips



Catalog No.	Style	Material	Finish	OAL mm	A mm	B mm	Pkg.
2A.SA.DN	Style 2A	Anti-Acid/Anti-Mag SS	ESD Foam	120	0.20	2.20	each

**III Style 3**

ESD foam grip tweezers with very sharp, fine tips

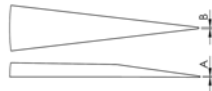

Catalog No.	Style	Material	Finish	OAL mm	A mm	B mm	Pkg.
3.SA.DN	Style 3	Anti-Acid/Anti-Mag SS	ESD Foam	120	0.15	0.20	each

**III Style 3C**

ESD foam grip tweezers with very sharp, fine tips

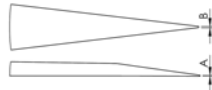

Catalog No.	Style	Material	Finish	OAL mm	A mm	B mm	Pkg.
3C.SA.DN	Style 3C	Anti-Acid/Anti-Mag SS	ESD Foam	110	0.15	0.10	each

**III Style 5**

ESD foam grip tweezers with fine, sharp tips



Catalog No.	Style	Material	Finish	OAL mm	A mm	B mm	Pkg.
5.SA.DN	Style 5	Anti-Acid/Anti-Mag SS	ESD Foam	110	0.15	0.10	each

**III Style 7**

ESD foam grip tweezers with fine, curved tips



Catalog No.	Style	Material	Finish	OAL mm	A mm	B mm	Pkg.
7.SA.DN	Style 7	Anti-Acid/Anti-Mag SS	ESD Foam	120	0.15	0.10	each

**III Style 15AGW**

ESD foam grip cutting tweezers with cutting tips, predominantly angled blades.

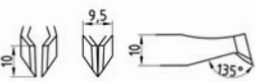

Catalog No.	Style	Material	Finish	OAL mm	A mm	B mm	Pkg.
15AGW.C.DN	Style 15AGW	Carbon Steel	ESD Foam	120	9.50	10.00	each

## Component Positioning Tweezers

Designed specifically to hold delicate components firmly and safely.

### Style 5577

Component positioning tweezers - serrated handles: straight, copper cooling jaws (10mmx6mm)



Catalog No.	Style	Material	Serration	OAL mm	A mm	B mm	Pkg.
5577.SA	Style 5577	AntiAcid/AntiMag SS	Serrated handles	145	3	6	each

### Style 571

Component positioning tweezers - serrated handles: straight, grooved, for 2.5-5mm cylindrical device

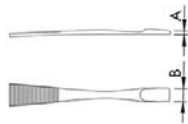

Catalog No.	Style	Material	Serration	OAL mm	A mm	B mm	Pkg.
571.SA	Style 571	AntiAcid/AntiMag SS	Serrated handles	145	1.5	5	each

### Style 572

Component positioning tweezers - serrated handles: straight, grooved, for 2.5-5mm cylindrical device



Catalog No.	Style	Material	Serration	OAL mm	A mm	B mm	Pkg.
572.SA	Style 572	AntiAcid/AntiMag SS	Serrated handles	145	1.5	6	each

### Style 577

Component positioning tweezers - serrated handles: straight, grooved, for 2mm cylindrical device

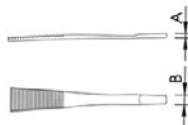

Catalog No.	Style	Material	Serration	OAL mm	A mm	B mm	Pkg.
577.SA	Style 577	AntiAcid/AntiMag SS	Serrated handles	125	1	3	each

### Style 578

Component positioning tweezers - serrated handles: straight, grooved, for 2mm cylindrical device



Catalog No.	Style	Material	Serration	OAL mm	A mm	B mm	Pkg.
578.SA	Style 578	AntiAcid/AntiMag SS	Serrated handles	120	1.3	3.5	each

### Style 582

Component positioning tweezers - serrated handles: straight, grooved, for 1mm cylindrical device

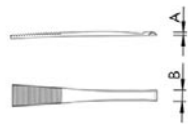

Catalog No.	Style	Material	Serration	OAL mm	A mm	B mm	Pkg.
582.SA	Style 582	AntiAcid/AntiMag SS	Serrated handles	120	0.9	3.5	each



## EMS LINE OF TWEEZERS

### Super Slim and Long Tweezers

These long and slender tweezers work well in multiple precision applications and are especially well suited for working near heat sources. Made from SA steel.

#### III Style 60

Sharp, relieve tips.



Catalog No.	Description	AOL	Qty.
78348-60	EMS 60, SA	140mm	each

#### III Style 64A

Sharp, curve tips.



Catalog No.	Description	AOL	Qty.
78351-64A	EMS 64A, SA	140mm	each

#### III Style 65A

Sharp, bent tips.



Catalog No.	Description	AOL	Qty.
78351-65A	EMS 65A, SA	140mm	each

#### III Style 66

Sharp, double bent tips allow more visibility.



Catalog No.	Description	AOL	Qty.
78351-66	EMS 66, SA	140mm	each

#### III Style SS

Long and narrow straight tips.



Catalog No.	Description	AOL	Qty.
72919-SS	EMS SS, SA	140mm	each
72919-SSUF	EMS SS, NC – Ultra Fine	140mm	each

#### III Style SSL

Long and narrow tips, ergonomic shape. Length: 6" (150mm)



Catalog No.	Description	AOL	Qty.
78353-SSL	EMS SSL, SA	150mm	each

## You may also need...Sterilizing Trays

#### III Sterilizing Tray – Plastic

- Trays are perforated
- Made from high Strength Ultem® Plastic
- Autoclave, Steam, Dry Heat, Chemical Sterilization is possible
- Has an extended Life Cycle
- Trays are stackable
- Economical and Flexible Design

Has flexible silicone mats which offer flexibility to layout the instruments for sterilization. A unique "grid" system exists in the base, tray and lid, making it easy to install the mat required, protecting yours instruments properly. The trays are stackable and they have integral feet in base and corner ridges on lids which allow for easier handling in the autoclave and for storage.

All bases have pebble-type surface to keep mats from sticking.

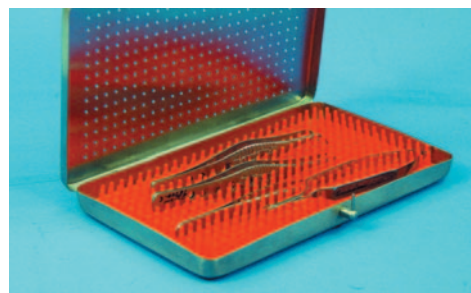
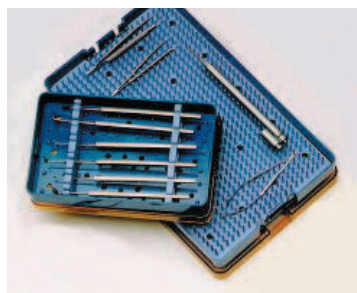

Catalog No.	Tray Size in (mm)	Description	Qty.
66114-01	6 x 2.5 x 1.25 (151 x 64 x 32)	Tray with Silicone Mat & Lid	each
66114-02	7.5 x 4 x 1.5 (191 x 102 x 38)	Tray with Silicone Mat & Lid	each
66114-03	10 x 6 x 1.5 (254 x 152.4 x 38)	Tray with Silicone Mat & Lid	each
66114-05	10 x 6 x 1.5 (254 x 152.4 x 38)	Deep Base/Insert Tray/2 Mats/Lid	each

#### III Stainless Steel Instrument Sterilizing Tray

This perforated tray comes complete with a silicone mat and a unique locking feature.

Catalog No.	Description	Qty.
66112-01	Tray 8½" x 5" x ¾"	each
66112-02	Tray 8" x 9¾" x ¾"	each
66112-03	Tray 16" x 9½" x ¾"	each

## Flat-Tip Tweezers

Made from SA steel and they have serrated grips.

### III Style 125

Smooth, flat, and no scratch tips.



Catalog No.	Description	AOL	Tip Width	Qty.
78332-125	EMS 125	120mm	4.4mm	each

### III Style 125A

Same as #125 but with elongated tips.



Catalog No.	Description	AOL	Tip Width	Qty.
78332-125A	EMS 125A	120mm	2.7mm	each

### III Style 127

Thin and square tips, straight.



Catalog No.	Description	AOL	Tip Width	Qty.
72972-SP	EMS 127	105mm	—	each

### III Style 128

Thin and square tips, curved.



Catalog No.	Description	AOL	Tip Width	Qty.
72972-AP	EMS 128	105mm	—	each

### III Style 33A

Flat round tips.



Catalog No.	Description	AOL	Tip Width	Qty.
78333-33A	EMS 33A	115mm	6.6mm	each

### III Style 34A

Smooth and wide tips, good for handling delicate parts.



Catalog No.	Description	AOL	Tip Width	Qty.
78334-34A	EMS 34A	120mm	6.3mm	each

### III Style 35A

Smooth and short wide tips.



Catalog No.	Description	AOL	Tip Width	Qty.
78335-35A	EMS 35A	120mm	6.7mm	each

### III Style 35B

Same as Style 35A, but with curved tips.



Catalog No.	Description	AOL	Tip Width	Qty.
78211-01	Tweezers Style 35B	120mm	6.7mm	each
78211-06	Tweezers Style 35B	120mm	6.7mm	6/pk.

### III Style 36A

Same as #34A but upward bent tips



Catalog No.	Description	AOL	Tip Width	Qty.
78336-36A	EMS 36A	120mm	6.2mm	each

### III Style 574/A

Flat and tips bent upward.



Catalog No.	Description	AOL	Tip Width	Qty.
78212-01	EMS Style 574/A	145	6mm	each
78212-06	EMS Style 574/A	145	6mm	6/pk.

## EMS LINE OF TWEEZERS

### Heavy Duty Tweezers

Comfortable and precision handling of electronic components for soldering operations. Available in straight or bent (Suffix B) version and various lengths. For very firm hold available in stainless steel (SA) or nickel plated (NP).

#### DIMENSION GUIDE:

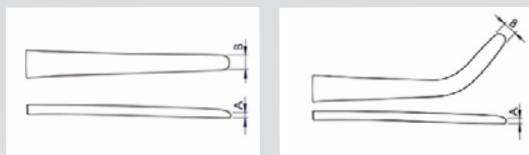

#### III Style 29

Reverse action strong tweezers: straight, strong, blunt, rounded tips, rhomb serrated. Length: 165mm



Cat. No.	Material	A mm	B mm	Pkg.
29.SA	AntiAcid/AntiMag SS, Red plastic handle	1.5	2.5	each

#### III Style 30

Reverse action strong tweezers: strong, blunt, bent, rounded tips, rhomb serrated. Length: 160mm



Cat. No.	Material	A mm	B mm	Pkg.
30.SA	AntiAcid/AntiMag SS, Red plastic handle	1.5	2.5	each

#### III Style 31

Reverse action strong tweezers: straight, sharp, fine tips. Length: 115mm



Cat. No.	Material	A mm	B mm	Pkg.
31.SA	AntiAcid/AntiMag SS	0.3	0.2	each

#### III Style 57A

Strong tweezers - locking system: straight, strong, blunted tips, rhomb serrated. Length: 140mm



Cat. No.	Material	A mm	B mm	Pkg.
57A.SA	AntiAcid/AntiMag SS	0.5	0.7	each

#### III Style 7313

Strong tweezers - serrated handles: straight, flat, round, line serrated. Length: 130mm



Cat. No.	Material	A mm	B mm	Pkg.
7313.C.NP	Carbon Steel, Nickel Plated full body	1.5	3.3	each
7313.SA	AntiAcid/AntiMag SS	1.5	3.3	each

#### III Style 7313B

Strong tweezers - serrated handles: flat, round, bent, line serrated. Length: 130mm



Cat. No.	Material	A mm	B mm	Pkg.
7313B.C.NP	Carbon Steel, Nickel Plated full body	1.5	3.3	each

#### III Style 7314

Strong tweezers - serrated handles: straight, flat, round, line serrated. Length: 145mm



Cat. No.	Material	A mm	B mm	Pkg.
7314.C.NP	Carbon Steel, Nickel Plated full body	1.5	3.5	each
7314.SA	AntiAcid/AntiMag SS	1.5	3.5	each

#### III Style 7314B

Strong tweezers - serrated handles: strong, rounded, blunted, bent, line serrated. Length: 130mm



Cat. No.	Material	A mm	B mm	Pkg.
7314B.C.NP	Carbon Steel, Nickel Plated full body	1.5	3.5	each
7314B.SA	AntiAcid/AntiMag SS	1.5	3.5	each

#### III Style 7316

Strong tweezers - serrated handles: straight, strong, rounded, blunted, line serrated. Length: 160mm



Cat. No.	Material	A mm	B mm	Pkg.
7316.C.NP	Carbon Steel, Nickel Plated full body	1.8	3.5	each

#### III Style 7316B

Strong tweezers - serrated handles: strong, rounded, blunted, bent, line serrated. Length: 155mm



Cat. No.	Material	A mm	B mm	Pkg.
7316B.C.NP	Carbon Steel, Nickel Plated full body	1.8	3.5	each
7316B.SA	AntiAcid/AntiMag SS	1.8	3.5	each

## Heavy Duty Tweezers (continued)

## III Style 7318

Strong tweezers - serrated handles: straight, strong, rounded, blunted, line serrated



Catalog No.	Style	Material	Finish	OAL mm	A mm	B mm	Pkg.
7318.C.NP	Style 7318	Carbon Steel	Nickel Plated full body	185	2	3.8	each

## III Style 7318B

Strong tweezers - serrated handles: strong, rounded, blunted, bent, line serrated



Catalog No.	Style	Material	Finish	OAL mm	A mm	B mm	Pkg.
7318B.C.NP	Style 7318B	Carbon Steel	Nickel Plated full body	180	2	3.8	each

## III Style 7320

Strong tweezers - serrated handles: straight, strong, rounded, blunted, line serrated



Catalog No.	Style	Material	Finish	OAL mm	A mm	B mm	Pkg.
7320.C.NP	Style 7320	Carbon Steel	Nickel Plated full body	200	2	4	each
7320.SA	Style 7320	AntiAcid/AntiMag SS	-	200	2	4	each

## III Style 7320B

Strong tweezers - serrated handles: strong, rounded, blunted, bent, line serrated



Catalog No.	Style	Material	Finish	OAL mm	A mm	B mm	Pkg.
7320B.C.NP	Style 7320B	Carbon Steel	Nickel Plated full body	195	2	4	each
7320B.SA	Style 7320B	AntiAcid/AntiMag SS	-	195	2	4	each

## III Style 7325

Strong tweezers - serrated handles: straight, strong, rounded, blunted, line serrated



Catalog No.	Style	Material	Finish	OAL mm	A mm	B mm	Pkg.
7325.C.NP	Style 7325	Carbon Steel	Nickel Plated full body	250	2	3.5	each
7325.SA	Style 7325	AntiAcid/AntiMag SS	-	250	2	3.5	each

## III Style 7325B

Strong tweezers - serrated handles: strong, rounded, blunted, bent, line serrated



Catalog No.	Style	Material	Finish	OAL mm	A mm	B mm	Pkg.
7325B.C.NP	Style 7325B	Carbon Steel	Nickel Plated full body	250	2	4	each
7325B.SA	Style 7325B	AntiAcid/AntiMag SS	-	250	2	4	each

## III Style 7330

Strong tweezers - serrated handles: straight, strong, rounded, blunted, line serrated



Catalog No.	Style	Material	Finish	OAL mm	A mm	B mm	Pkg.
7330.C.NP	Style 7330	Carbon Steel	Nickel Plated full body	300	2.5	5	each
7330.SA	Style 7330	AntiAcid/AntiMag SS	-	300	2.5	5	each

## III Style 7330B

Strong tweezers - serrated handles: strong, rounded, blunted, bent, line serrated



Catalog No.	Style	Material	Finish	OAL mm	A mm	B mm	Pkg.
7330B.C.NP	Style 7330B	Carbon Steel	Nickel Plated full body	295	2.5	5	each
7330B.SA	Style 7330B	AntiAcid/AntiMag SS	-	295	2.5	5	each

EMS LINE OF TWEEZERS

Cutting Tweezers

These Cutting Tweezers have been designed to meet requirements for different applications. With a high precision cut and narrow working areas, the tweezers are available with angled blades, parallel blades, and predominantly angled blades. Perfect for cutting soft wires, copper, gold, silver, and magnetic wires.

**Carbon steel** (Material number 1.1221, Ck60, AISI 1060)

- Contains from 0,57-0,65 wt% carbon
- Magnetizable
- Will be hardened by heat treatment, max. hardness 57 HRC
- Poor resistance to corrosion
- Used where strength and/or hardness are of primary concern.
- Typical applications include tweezers and cutting tools for the electronic industry, watch-makers, jewelers applications.

III Style 14A

High precision cutting tweezers.  
Predominantly angled blades.  
Length: 115mm.

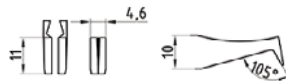

Cat. No.	Material	A mm	B mm	Pkg.
78325-14A	Carbon Steel	2.3	11	each

III Style 14AGW

High precision cutting tweezers.  
Predominantly angled blades.  
Length: 115mm.

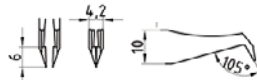

Cat. No.	Material	A mm	B mm	Pkg.
78325-14AG	Carbon Steel	2.1	6	each

III Style 15A

High precision cutting tweezers.  
Angled cutting blades.  
Length: 120mm.



Cat. No.	Material	A mm	B mm	Pkg.
7802-15A	Carbon Steel	4.25	12.00	each

III Style 15AFW

High precision cutting tweezers.  
Predominantly angled blades.  
Length: 115mm.



Cat. No.	Material	A mm	B mm	Pkg.
78325-15AF	Carbon Steel	4.25	8	each

III Style 15AGHM

High precision cutting tweezers.  
Tungsten carbide insert.  
Predominantly angled blades.  
Length: 115mm.



Cat. No.	Material	A mm	B mm	Pkg.
78325-03	AntiAcid/AntiMag SS	5	10	each

III Style 15AGW

High precision cutting tweezers.  
Predominantly angled blades.  
Length: 115mm.

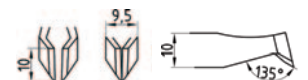

Cat. No.	Material	A mm	B mm	Pkg.
78325-04	Carbon Steel	4.75	10.00	each

III Style 15AP

High precision cutting tweezers.  
Parallel blades.  
Length: 120mm.

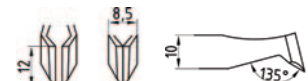

Cat. No.	Material	A mm	B mm	Pkg.
78325-05	Carbon Steel	4.25	12	each

Cutting Tweezers (continued)

III Style 15ARW

High precision cutting tweezers.  
Parallel blades.  
Length: 115mm.

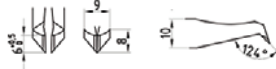

Cat. No.	Material	A mm	B mm	Pkg.
78325-06	Carbon Steel	4.5	6	each

III Style 15ASW

High precision cutting tweezers.  
Predominantly angled blades.  
Length: 115mm.



Cat. No.	Material	A mm	B mm	Pkg.
15ASW.C	Carbon Steel	3.6	10	each

III Style 152

High precision cutting tweezers.  
Predominantly angled blades.  
Length: 100mm.

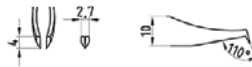

Cat. No.	Material	A mm	B mm	Pkg.
78325-152	Stainless Steel	1.35	4.3	each

**For ESD Rubber Coated Cutting Tweezers, see page 21.**  
**For ESD Epoxy Coated Cutting Tweezers, see page 23.**  
**For ESD Foam Coated Cutting Tweezers, see page 28.**

TIP DIMENSION GUIDE:

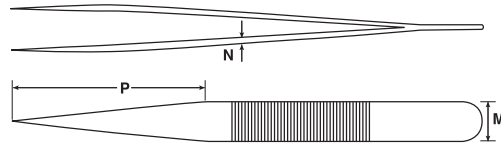

III Style 15A

For cutting hair sprigs, electronic component wires, copper, gold, silver and other soft wires. Large head, oblique strong cut at the cutter's tip. Cutting edge is limited to the tip area. Length 111mm.



Cat. No.	M mm	N mm	P mm	Pkg.
7802-15A	11.00	3.00	24.00	each

III Style 15AP

For cutting hair sprigs, electronic component wires, copper, gold, silver and other soft wires. Large head, parallel, strong cut. Length 111mm.



Cat. No.	M mm	N mm	P mm	Pkg.
7802-15AP	11.00	3.00	24.00	each

You may also need...

III Beaker-Store; Instrument Store

This unique beaker has a silicone bottom that allows you to store all of your tweezers and tools in cleaning solution and never damage the tips. Instruments may be placed in the beaker with the tips only immersed in distilled water and or cleaning solution. This allows the instruments to be kept clean and safe and ready to use. The Silicone bottom prevents the tips of the instruments from being damaged and the top of the beaker is compartmentalized and segmented allowing for each tool to be kept separate.

The beaker measures 10 cm in diameter and it is 8 cm in height.



Catalog No.	Description	Qty.
68113-05	Beaker Store	each

EMS LINE OF TWEEZERS

Wafer Tweezers

These tweezers are designed for the handling of delicate and fragile silicon wafers, scintillation discs, glass slides, coverslips etc. Made from antimagnetic/anti-acid steel with a very smooth surface and a non-glare finish.

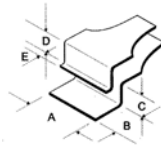

III Style 2W

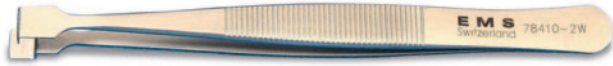

Cat. No.	Description	A mm	B mm	C mm	D mm	E mm	Qty.
78410-2W	EMS Style 2W	6.50	5.00	2.50	4.00	—	each

III Style 2WF

Wafer tweezers - serrated handles: handling 2", top fingers, stepped bottom paddle. Length: 120mm.



Cat. No.	Description	A mm	B mm	C mm	D mm	E mm	Qty.
2WF.SA	EMS Style 2WF	6.50	9.00	2.50	4.00	2.50	each

III Style 2WFCPR

Tips are made of PEEK/CF30, hold wafers gently. Replacement tips available.



Cat. No.	Description	A mm	B mm	C mm	D mm	E mm	Qty.
78410-2WFC	EMS Style 2WFCPR	6.60	2.00	2.00	3.50	4.50	each
78410-2WFR	Replacement tips						set

III Style 2WFG

Wafer tweezers - serrated handles: handling 2", top fingers, stepped bottom paddle with grid. Length: 120mm.



Cat. No.	Description	A mm	B mm	C mm	D mm	E mm	Qty.
2WFG.SA	EMS Style 2WFG	6.50	9.00	2.50	4.00	2.50	each

III Style 2WL

Wafer tweezers - serrated handles: handling 2", top lip, stepped bottom paddle. Length: 120mm.



Cat. No.	Description	A mm	B mm	C mm	D mm	E mm	Qty.
2WL.SA	EMS Style 2WL	6.50	—	—	—	—	each

III Style 3WF



Cat. No.	Description	A mm	B mm	C mm	D mm	E mm	Qty.
78411-3WF	EMS Style 3WF	9.50	10.00	2.50	4.00	2.50	each

III Style 3WL

Wafer tweezers - serrated handles: handling 3", top lip, stepped bottom paddle. Length: 120mm.



Cat. No.	Description	A mm	B mm	C mm	D mm	E mm	Qty.
3WL.SA	EMS Style 3WL	9.50	10.00	2.50	4.00	2.50	each

III Style 4WF

Wafer tweezers - serrated handles: handling 3", top fingers, stepped bottom paddle. Length 125mm.



4WF.SA.T "PTFE" coated

Cat. No.	Description	A mm	B mm	C mm	D mm	E mm	Qty.
78414-4WF	EMS Style 4WF	12.00	9.00	—	4.00	2.50	each
4WF.SA.T	EMS Style 4WF "PTFE" coated	12.00	9.00	—	4.00	2.50	each

III Style 4WFCPR

Tips are made of PEEK/CF30, hold wafers gently. Replacement tips are available.



Cat. No.	Description	A mm	B mm	C mm	D mm	E mm	Qty.
78414-4WFC	EMS Style 4WFCPR	12.00	2.00	2.00	3.50	4.50	each
78414-4WFR	Replacement tips						set

III Style 4WFG

Wafer tweezers - serrated handles: handling 3", top fingers, stepped bottom paddle with grid. Length: 125mm.



Cat. No.	Description	A mm	B mm	C mm	D mm	E mm	Qty.
4WFG.SA	EMS Style 4WFG	12.00	9.00	2.50	4.00	2.50	each

III Style 4WL

Wafer tweezers - serrated handles: handling 3", top lip, stepped bottom paddle. Length: 125mm.



Cat. No.	Description	A mm	B mm	C mm	D mm	E mm	Qty.
4WL.SA	EMS Style 4WL	12.00	7.50	3.00	4.00	2.50	each

## Wafer Tweezers (continued)

## III Style 5WF

Wafer tweezers - serrated handles: handling 5, top fingers, stepped bottom paddle. Length: 130mm.



Cat. No.	Description	A mm	B mm	C mm	D mm	E mm	Qty.
5WF.SA	EMS Style 5WF	16.00	8.50	2.50	4.00	2.50	each

## III Style 5WL

Wafer tweezers - serrated handles: handling 5", top lip, stepped bottom paddle. Length: 130mm.



Cat. No.	Description	A mm	B mm	C mm	D mm	E mm	Qty.
5WL.SA	EMS Style 5WL	16.00	8.50	2.50	4.00	2.50	each

## III Style 6WF

Wafer tweezers - serrated handles: handling 6", top fingers, stepped bottom paddle. Length: 130mm.



Cat. No.	Description	A mm	B mm	C mm	D mm	E mm	Qty.
6WF.SA	EMS Style 6WF	20.00	8.50	2.50	4.00	2.50	each
6WF.SA.T	EMS Style 6WF "PTFE" Coated	20.00	8.50	2.50	4.00	2.50	each

## III Style 6WL

Wafer tweezers - serrated handles: handling 6", top lip, stepped bottom paddle. Length: 130mm.



Cat. No.	Description	A mm	B mm	C mm	D mm	E mm	Qty.
6WL.SA	EMS Style 6WL	20.00	8.50	2.50	4.00	2.50	each

## III Style 8WF

Wafer tweezers - serrated handles - tips: handling 6", top fingers, stepped bottom paddle. OAL: 135mm



Cat. No.	Description	A mm	B mm	C mm	D mm	E mm	Qty.
78420-8WF	EMS Style 8WF	28.50	12.00	2.20	3.50	2.50	each

## III Style 8WNY

Wafer tweezers - Anti-Acid/Anti-Mag SS, Nylon tips - serrated handles - tips: handling 8", top lip, stepped bottom paddle. OAL: 150mm



Cat. No.	Description	A mm	B mm	C mm	D mm	E mm	Qty.
78422-8WNY	EMS Style 8WNY	65.00	19.00	1.30	2.00	—	each

## III Style 35S



Cat. No.	Description	A mm	B mm	C mm	D mm	E mm	Qty.
78411-35S	EMS Style 35S	29.00	5.50	—	3.00	—	each

## III Style 38FG



Cat. No.	Description	A mm	B mm	C mm	D mm	E mm	Qty.
78411-38FG	EMS Style 38FG	9.50	11.00	—	4.00	2.50	each

## III Style 39S2



Cat. No.	Description	A mm	B mm	C mm	D mm	E mm	Qty.
78412-39S2	EMS Style 39S2	6.50	8.50	—	5.50	2.40	each

## III Style 39S3



Cat. No.	Description	A mm	B mm	C mm	D mm	E mm	Qty.
78412-39S3	EMS Style 39S3	9.50	8.50	—	5.50	2.40	each

## III Style 41W



Cat. No.	Description	A mm	B mm	C mm	D mm	E mm	Qty.
78414-41W	EMS Style 41W	28.00	12.00	—	5.00	5.00	each



## EMS LINE OF TWEEZERS

### Wafer Tweezers (continued)

#### III Style 43WFG



Catalog No.	Description	A mm	B mm	C mm	D mm	E mm	Qty.
78414-43WFG	EMS Style 43WFG	9.50	8.50	—	3.50	2.50	each

#### III Style 44WF



Catalog No.	Description	A mm	B mm	C mm	D mm	E mm	Qty.
78414-44WF	EMS Style 44WF	12.00	8.50	—	3.50	2.50	each

#### III Style 45WF

Wafer tweezers - serrated handles: handling 5", top fingers, flat bottom paddle. "PTFE" coated. Length: 130mm.



Catalog No.	Description	A mm	B mm	C mm	D mm	E mm	Qty.
45WF.SA.T	EMS Style 45WF "PTFE" coated	16.00	—	—	—	—	each

#### III Style 48WF

Wafer tweezers - serrated handles: handling 6", top fingers, flat bottom paddle. Length: 135mm.



Catalog No.	Description	A mm	B mm	C mm	D mm	E mm	Qty.
78414-48WF	EMS Style 48WF	28.00	9.00	—	4.00	2.50	each

#### III Style 85C

Wafer tweezers - serrated handles: handling 2", top lip, stepped bottom paddle. Length: 115mm.



Catalog No.	Description	A mm	B mm	C mm	D mm	E mm	Qty.
85C.SA	EMS Style 85C	7.00	4.50	3.00	4.00	2.00	each

#### III Style 600M — Bent

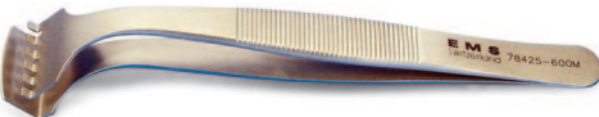

Catalog No.	Description	A mm	B mm	C mm	D mm	E mm	Qty.
78425-600M	EMS Style 600M	20.00	11.00	—	—	2.30	each

#### III Style 96



Catalog No.	Description	A mm	B mm	C mm	D mm	E mm	Qty.
78426-96	EMS Style 96	14.50	10.50	9.00	—	—	each

#### III Plastic Wafer Tweezers

Designed for low cost and ease of use with the highest quality of materials.



78310-41



78310-51

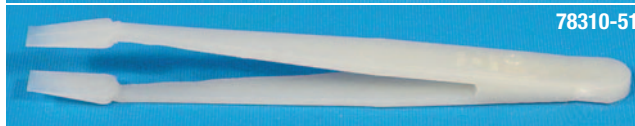

78310-61

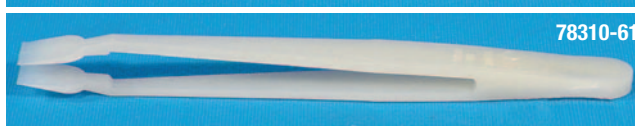

78310-07



78311-4A



78311-5A2

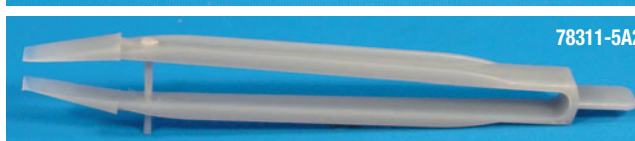

Catalog No.	Description	Qty.
78310-04	Glass-filled Delrin for delicate, thin, and flat objects, 11.3cm long	each
78310-41	Same as #78310-04 but made from linear polyethylene, acid resistant	each
78310-05	Glass filled Delrin, useful for handling coverslips or glass slides 11.3 cm long	each
78310-51	Same as #78310-05 but made from linear polyethylene, acid resistant	each
78310-06	Glass-filled Delrin, good for glass slide, wafer handling, 11.3cm long	each
78310-61	Same as #78310-06 but made from linear polyethylene, Acid resistant	each
78310-07	Glass-filled Delrin with extra wide point, 11.3cm long	each
78310-71	Same as #78310-07 but made from linear polyethylene, Acid resistant	each
78311-4A	Fluorocarbon, acid resistant, extra long with line up pin, 16.5cm	each
78311-5A2	Linear polyethylene, acid resistant, 16.5cm long	each

#### III Plastic Wafer Pliers

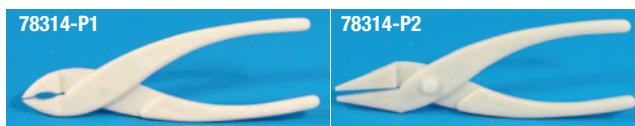

Catalog No.	Description	Qty.
78314-P1	Glass-filled Delrin pliers. Serrated jaws, hold tubes securely, resistant to most solvents	each
78314-P2	Glass-filled Nylon pliers, flat smooth jaws. Good for handling soft materials. Protected from damage. 15 cm long	each

Wafer Tweezers (continued)

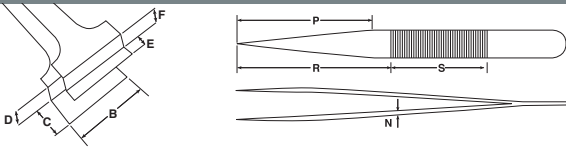

**DIMENSION GUIDE**

**III Style 41LB6**



**Dimensions:**  
**B:** 19.50mm, **C:** 9.00mm, **D:** —, **E:** 2.00mm, **F:** 3.00mm  
**M:** 11.00mm, **N:** 2.00mm, **R:** 52.00mm, **S:** 42.00mm

Catalog No.	Description	OAL mm	Qty.
7803-41LB6	Style 41LB6	130	each

**III Style 41LB8**



**Dimensions:**  
**B:** 27.00mm, **C:** 9.00mm, **D:** —, **E:** 2.00mm, **F:** 3.00mm  
**M:** 12.00mm, **N:** 2.00mm, **R:** 56.00mm, **S:** 42.00mm

Catalog No.	Description	OAL mm	Qty.
7803-41LB8	Style 41LB8	135	each

**III Style 43LB12**

**Dimensions:**  
**B:** 40.00mm, **C:** 26.00mm, **D:** 7.00mm, **E:** 2.00mm, **F:** 3.00mm  
**M:** 13.00mm, **N:** 2.00mm, **R:** 86.00mm, **S:** 42.00mm

Catalog No.	Description	OAL mm	Qty.
7803-43LB12	Style 43LB12	200	each

**III Style 43LB14**

**Dimensions:**  
**B:** 48.50mm, **C:** 35.00mm, **D:** 8.00mm, **E:** 2.00mm, **F:** 3.00mm  
**M:** 13.00mm, **N:** 2.00mm, **R:** 95.00mm, **S:** 42.00mm

Catalog No.	Description	OAL mm	Qty.
7803-43LB14	Style 43LB14	208	each

**III Style ARG**

For large size wafers, as well as for holding slides in the lab.



**Dimensions:**  
**B:** 60.00mm, **C:** 3.00mm, **D:** 3.00mm, **E:** 3.00mm, **F:** 3.00mm  
**M:** 11.00mm, **N:** 2.00mm, **R:** 52.00mm, **S:** 42.00mm

Catalog No.	Description	OAL mm	Qty.
7803-ARG	Style ARG	130	each

**III Style NW**



**Dimensions:**  
**B:** 16.00mm, **C:** 6.00mm, **D:** —, **E:** —, **F:** —  
**M:** 11.00mm, **N:** 2.00mm, **R:** 52.00mm, **S:** 42.00mm

Catalog No.	Description	OAL mm	Qty.
7803-NW	Style NW	130	each



You may also need... Wafer Cleaving Tools and General Accessories

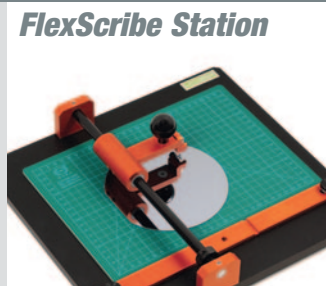

**FlexScribe Station**



**Small Sample Scribing and Cleaving Kit**



**Small Sample Cleaver**

See our website for a full selection of Silicon Wafer Cleaving Tools, and General Accessories.

# EMS LINE OF TWEEZERS

## General Purpose Tweezers

### III Style 119

Fine and extremely accurate serration tips. Length: 6" (150mm)



Catalog No.	Description	Qty.
78354-119	EMS 119	each

### III Style 119L

Long, and strong tips. Length: 7" (180mm)



Catalog No.	Description	Qty.
78354-119L	EMS 119L	each

### III Style 120

Strong and dull tips. Length: 6" (150mm)



Catalog No.	Description	Qty.
78355-120	EMS 120	each

### III Style 120A

Short, fine and sturdy tips. Length: 4 1/4" (110mm)

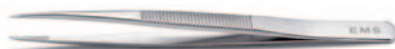

Catalog No.	Description	Qty.
78355-120A	EMS 120A	each

### III Style 121

Serrated handles. Tips: straight, very strong, blunt, rhomb serrated. Length: 6 1/4" (160mm)

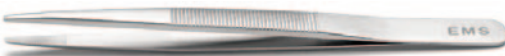

Catalog No.	Description	Qty.
78356-121	EMS 121	each

### III Style 122

Fine, bent, serrated tips. Length: 6" (150mm)

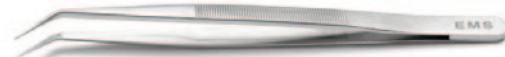

Catalog No.	Description	Qty.
78357-122	EMS 122	each

### III Style 123

Fine, double bent tips. Length: 6" (150mm)



Catalog No.	Description	Qty.
78358-123	EMS 123	each

### III Style 124

Same as 122 but stronger and blunt tips. Length: 6" (150mm)



Catalog No.	Description	Qty.
78359-124	EMS 124	each

### III Style 321

Flat and elongated tips. Length: 4 3/4" (120mm)



Catalog No.	Description	Qty.
78362-321	EMS 321	each

### III Style 646

Curved, serrated tips with guide pin. Length 6" (150mm)



Catalog No.	Description	Qty.
78365-646	EMS 646	each

### III Style 647

Serrated handles - tips: straight, strong, blunt, precision, rhomb serrated. Length: 5" (125mm)



Catalog No.	Description	Qty.
78365-647	EMS 647	each

### III Style 649

Nickel plated - serrated handles - tips: bent, strong, fine, line serrated. Strong, fine, bent, alignment pin. Length: 6" (155mm)



Catalog No.	Description	Qty.
78365-649	EMS 649	each

### III Style 775

Bent and fine tips with PVC coated handle. Length: 6 1/8" (155mm)



Catalog No.	Description	Qty.
78369-775	EMS 775	each

### III Style 61A

Curved tips with slits on both tips. Used for handling thin discs. Length: 4 1/4" (110mm)



Catalog No.	Description	Qty.
78349-61A	EMS 61A	each

### III Style GG

Long and strong tips. Length: 5" (130mm). Nickel Plated



Catalog No.	Description	Qty.
78372-GG	EMS GG	each

## EMS Fiber Tip Tweezers

Antimagnetic Steel handles.

### High-performance Plastic type CP - PEEK/CF30

(Polyetheretherketone reinforced with 30 wt% carbon fiber)

- Very hard, high tensile and flexural strength.
- High heat (260 to 300°C) resistance to thermal aging.
- Excellent chemical resistance.
- ESD safe – low surface resistivity (102 Ohm).

### Engineering Plastic type CF - PA66/CF30

(Polyamide 66 reinforced with 30 wt% carbon fiber)

- Heat stable (-40°C to 190°C).
- Rigidity, excellent tensile strength and flexural strength.
- Good chemical resistance (oils, greases, fuels, non-polar solvents); not resistant to strong acids, alkalis and hot water or steam.
- ESD safe, (avoids dust attraction, sparks, ignition sources).
- Good conductivity.

### Non Conductive Plastic RF – PET/GF30

(Polyethylene terephthalate reinforced with 30 wt% glass fiber)

- High tensile and flexural strength.
- Good chemical resistance and low moisture absorption.
- Electrically insulating.
- High temperature capability.
- White in color.

## DIMENSION GUIDE



### III Style 00



Catalog No.	Description	A mm	B mm	C mm	Qty.
78080-CP	EMS 00 PEEK	130	1.00	2.00	each
78080-CF	EMS 00 CF	130	1.00	2.00	each

### III Style 2A



Catalog No.	Description	A mm	B mm	C mm	Qty.
78084-CP	EMS 2A PEEK	130	1.80	1.00	each
78084-CF	EMS 2A CF	130	1.80	1.00	each

### III Style 2AB



Catalog No.	Description	A mm	B mm	C mm	Qty.
78085-CP	EMS 2AB PEEK	130	1.80	1.00	each
78080-CF	EMS 2AB CF	130	1.80	1.00	each
78080-P	EMS 2AB PVDF	130	1.80	1.00	each

### III Style 3



Catalog No.	Description	A mm	B mm	C mm	Qty.
78090-CP	EMS 3 PEEK	130	1.00	2.00	each
78090-CF	EMS 3 CF	130	1.00	2.00	each
78090-CFZ	EMS 3 CF	130	1.00	2.00	dozen

### III Style 5



Catalog No.	Description	A mm	B mm	C mm	Qty.
78092-CP	EMS 5 PEEK	130	0.50	0.60	each
78092-CF	EMS 5 CF	130	0.50	0.60	each
78092-CFZ	EMS 5 CF	130	0.50	0.60	dozen

### III Style 5X



Catalog No.	Description	A mm	B mm	C mm	Qty.
78094-CP	EMS 5X PEEK	130	0.50	0.60	each
78094-CF	EMS 5X CF	130	0.50	0.60	each
78094-CFZ	EMS 5X CF	130	0.50	0.60	dozen

### III Style 7



Catalog No.	Description	A mm	B mm	C mm	Qty.
78095-CP	EMS 7 PEEK	130	0.60	0.60	each
78095-CF	EMS 7 CF	130	0.60	0.60	each

### III Style 248



Catalog No.	Description	A mm	B mm	C mm	Qty.
78014-CP	EMS 248 PEEK	130	10.00	1.80	each
78014-RF	EMS 248 RF	130	10.00	1.80	each
78014-RFZ	EMS 248 RF	130	10.00	1.80	dozen

### III Style 249



Catalog No.	Description	A mm	B mm	C mm	Qty.
78008-CF	EMS 249 CF	130	1.00	2.00	each

### III Style 250



Catalog No.	Description	A mm	B mm	C mm	Qty.
78016-CP	EMS 250 PEEK	130	10.00	1.80	each
78016-RF	EMS 250 RF	130	10.00	1.80	each

### III Style 259



Catalog No.	Description	A mm	B mm	C mm	Qty.
78010-CP	EMS 259 PEEK	130	0.60	1.00	each
78010-RF	EMS 259 RF	130	0.60	1.00	each
78010-RFZ	EMS 259 RF	130	0.60	1.00	dozen

### III Style 269



Catalog No.	Description	A mm	B mm	C mm	Qty.
78012-CP	EMS 269 PEEK	130	3.00	1.80	each
78012-CF	EMS 269 CF	130	3.00	1.80	each
78012-RF	EMS 269 RF	130	3.00	1.80	each
78012-RFZ	EMS 269 RF	130	3.00	1.80	dozen

For EMS Replaceable Tip Tweezers, see pages 42–47.

EMS LINE OF TWEEZERS

Plastic Replaceable Tip Tweezers

Specially designed for the electronics industry, these tweezers feature durable and self-aligning replacement tips, anti-magnetic stainless steel handles and are available with a variety of tip geometries and materials: they offer a significant cost savings. Excellent for handling sensitive electronic components, and ceramic and glass parts where non-metallic non-scratching is critical. Replaceable tip sets come with 2 tips and 3 screws. The easiest and most precise replacement system available in the tweezers market.

**Plastic Type: Carbon Fiber**

Typical applications include handling of sensitive components and devices (electronic components, micro-mechanical parts, glass and ceramic substrates, capillary, etc.)

- PA66/CF30 polyamide 66 reinforced with 30 wt% carbon fiber
- Heat stabilized
- Very high rigidity, excellent tensile and flexural strength, fatigue and creep resistance
- Low friction, self lubricating properties, excellent wear and abrasion resistance
- Good heat capability
- Good chemical resistance (oils, grease, fuels, non polar solvents); not resistant to strong acids, alkalis and hot water or steam
- ESD safe material, (avoid powder attraction, sparks generation, ignition sources).
- Very low coefficient of linear thermal expansion

**Plastic Type Carbon PEEK**

Typical applications include handling of components in cleaning/chemical/assembly processes also at high temperature (soldering)

- PEEK polyetheretherketone reinforced with carbon fiber
- Very hard, rigid, high tensile and flexural strength, very high wear resistance
- High heat capability (260-300°C), good dimension stability, low thermal linear expansion coefficient
- Excellent resistance to chemicals and aggressive agents, excellent resistance to thermal ageing
- ESD-safe material

**Plastic Type PVDF**

Typical applications include handling of very scratch- and contamination-sensitive components, cleaning and etching processes.

- Heat stabilized, high heat capability, continuous use up to 150°C
- Clean room and medical devices approved, low extraction value
- Excellent chemical resistance to mineral and organic acids, and solvents (hydrocarbons, alcohols, halogenated), resistant to halogens
- Outstanding resistance to hydrofluoric acid (40% conc., 90°C), nitric acid (50% conc., 90°C), hydrochloric acid (36% conc., 90°C)

**III Style 00**

Plastic replaceable tip tweezers with flat edges, thick tips.



Catalog No.	Style	Material	Tip Material	OAL mm	A mm	B mm	Pkg.
78325-19	Style 00	Anti-Acid/Anti-Mag SS	Carbon fiber	130	1.00	1.00	each
78325-45	Style 00 tips	-	Carbon fiber	40	1.00	1.00	set
78325-45P	Style 00 tips	-	PVDF	40	1.00	1.00	set

**III Style 2**

Tips: straight, very sharp, pointed.



Catalog No.	Style	Material	Tip Material	OAL mm	A mm	B mm	Pkg.
78325-2	Style 2	Anti-Acid/Anti-Mag SS	Carbon fiber	130	0.50	1.00	each
A2CF	Style 2 tips	—	Carbon fiber	40	0.50	1.00	set

**III Style 2A**

Plastic replaceable tip tweezers with wide flat duckbill tips.



Catalog No.	Style	Material	Tip Material	OAL mm	A mm	B mm	Pkg.
78325-28	Style 2A	Anti-Acid/Anti-Mag SS	Carbon fiber	130	0.50	2.00	each
78325-30	Style 2A Reverse Action	Anti-Acid/Anti-Mag SS	Carbon fiber	125	0.50	2.00	each
78325-57	Style 2A tips	-	Carbon fiber	40	0.50	2.00	set
2ACPR.SA	Style 2A	Anti-Acid/Anti-Mag SS	Carbon PEEK	130	0.50	2.00	each
78325-31	Style 2A Reverse Action	Anti-Acid/Anti-Mag SS	Carbon PEEK	125	0.50	2.00	each
78325-58	Style 2A tips	-	Carbon PEEK	40	0.50	2.00	set
78325-29	Style 2A	Anti-Acid/Anti-Mag SS	PVDF	130	0.50	2.00	each
78325-32	Style 2A Reverse Action	Anti-Acid/Anti-Mag SS	PVDF	125	0.50	2.00	each
78325-59	Style 2A tips	-	PVDF	40	0.50	2.00	set

## Plastic Replaceable Tip Tweezers (continued)

## III Style 2AB

Plastic replaceable tip tweezers with curved, wide, flat duckbill tips.



Catalog No.	Style	Material	Tip Material	OAL mm	A mm	B mm	Pkg.
2ABCFR.SA	Style 2AB	Anti-Acid/Anti-Mag SS	Carbon fiber	130	0.50	2.00	each
78325-55	Style 2AB tips	-	Carbon fiber	40	0.50	2.00	set
2ABCPR.SA	Style 2AB	Anti-Acid/Anti-Mag SS	Carbon PEEK	130	0.50	2.00	each
78325-56	Style 2AB tips	-	Carbon PEEK	40	0.50	2.00	set

## III Style 3

Plastic replaceable tip tweezers with very sharp, pointed tips.



Catalog No.	Style	Material	Tip Material	OAL mm	A mm	B mm	Pkg.
78325-35	Style 3	Anti-Acid/Anti-Mag SS	Carbon fiber	130	0.70	0.70	each
78325-61	Style 3 tips	-	Carbon fiber	40	0.70	0.70	set
3CPR.SA	Style 3	Anti-Acid/Anti-Mag SS	Carbon PEEK	130	0.70	0.70	each
A3CP	Style 3 tips	-	Carbon PEEK	40	0.70	0.70	set

## III Style 3C

Plastic replaceable tip tweezers with very sharp, pointed tips.



Catalog No.	Style	Material	Tip Material	OAL mm	A mm	B mm	Pkg.
78325-34	Style 3	Anti-Acid/Anti-Mag SS	Carbon fiber	115	0.70	0.70	each
78325-61	Style 3 tips	-	Carbon fiber	40	0.70	0.70	set

## III Style 5

Plastic replaceable tip tweezers with very fine tips.



Catalog No.	Style	Material	Tip Material	OAL mm	A mm	B mm	Pkg.
78325-37	Style 5	Anti-Acid/Anti-Mag SS	Carbon fiber	130	0.50	0.50	each
78325-39	Style 5 Reverse Action	Anti-Acid/Anti-Mag SS	Carbon fiber	125	0.50	0.50	each
78325-63	Style 5 tips	-	Carbon fiber	40	0.50	0.50	set
5CPR.SA	Style 5	Anti-Acid/Anti-Mag SS	Carbon PEEK	130	0.50	0.50	each
5XCPR.SA	Style 5 Reverse Action	Anti-Acid/Anti-Mag SS	Carbon PEEK	125	0.50	0.50	each
78325-64	Style 5 tips	-	Carbon PEEK	40	0.50	0.50	set
78325-38	Style 5	Anti-Acid/Anti-Mag SS	PVDF	130	0.50	0.50	each
78325-65	Style 5 tips	-	PVDF	40	0.50	0.50	set

## III Style 7

Plastic replaceable tip tweezers with curved, very fine tips.



Catalog No.	Style	Material	Tip Material	OAL mm	A mm	B mm	Pkg.
78325-40	Style 7	Anti-Acid/Anti-Mag SS	Carbon fiber	130	0.50	0.50	each
78325-66	Style 7 tips	-	Carbon fiber	40	0.50	0.50	each
7CPR.SA	Style 7	Anti-Acid/Anti-Mag SS	Carbon PEEK	130	0.50	0.50	each
78325-67	Style 7 tips	-	Carbon PEEK	40	0.50	0.50	each
78325-41	Style 7	Anti-Acid/Anti-Mag SS	PVDF	130	0.50	0.50	each
78325-68	Style 7 tips	-	PVDF	40	0.50	0.50	each

## EMS LINE OF TWEEZERS

## Plastic Replaceable Tip Tweezers (continued)

## III Style 242

Plastic replaceable tip tweezers with narrow, flat duckbill tips.



Catalog No.	Style	Material	Tip Material	OAL mm	A mm	B mm	Pkg.
78325-20	Style 242	Anti-Acid/Anti-Mag SS	Carbon fiber	130	0.50	1.50	each
78325-46	Style 242 tips	-	Carbon fiber	40	0.50	1.50	each
78325-21	Style 242	Anti-Acid/Anti-Mag SS	Carbon PEEK	130	0.50	1.50	each
78325-47	Style 242 tips	-	Carbon PEEK	40	0.50	1.50	each
78325-22	Style 242	Anti-Acid/Anti-Mag SS	PVDF	130	0.50	1.50	each
78325-48	Style 242 tips	-	PVDF	40	0.50	1.50	each

## III Style 246

Plastic replaceable tip tweezers with thin, angled head: 9mm 45°.



Catalog No.	Style	Material	Tip Material	OAL mm	A mm	B mm	Pkg.
78325-23	Style 246	Anti-Acid/Anti-Mag SS	Carbon fiber	125	0.50	0.50	each
78325-49	Style 246 tips	-	Carbon fiber	40	0.50	0.50	each
78325-49P	Style 246 tips	-	Carbon PEEK	40	0.50	0.50	each
78325-23P	Style 246	Anti-Acid/Anti-Mag SS	PVDF	125	0.50	0.50	each
78325-50P	Style 246 tips	-	PVDF	40	0.50	0.50	each

## III Style 249

Plastic replaceable tip tweezers with strong, thick tips.



Catalog No.	Style	Material	Tip Material	OAL mm	A mm	B mm	Pkg.
78325-24	Style 249	Anti-Acid/Anti-Mag SS	Carbon fiber	130	1.00	2.00	each
78325-50	Style 249 tips	-	Carbon fiber	40	1.00	2.00	each
78325-25	Style 249	Anti-Acid/Anti-Mag SS	Carbon PEEK	130	1.00	2.00	each
78325-51	Style 249 tips	-	Carbon PEEK	40	1.00	2.00	each
78325-25P	Style 249	Anti-Acid/Anti-Mag SS	PVDF	130	1.00	2.00	each
78325-51P	Style 249 tips	-	PVDF	40	1.00	2.00	each

## III Style 259

Plastic replaceable tip tweezers with strong, pointed tips.



Catalog No.	Style	Material	Tip Material	OAL mm	A mm	B mm	Pkg.
78325-26	Style 259	Anti-Acid/Anti-Mag SS	Carbon fiber	130	0.50	0.50	each
78325-52	Style 259 tips	-	Carbon fiber	40	0.50	0.50	set
259CPR.SA	Style 259	Anti-Acid/Anti-Mag SS	Carbon PEEK	130	0.50	0.50	each
78325-53	Style 259 tips	-	Carbon PEEK	40	0.50	0.50	set
78325-27	Style 259	Anti-Acid/Anti-Mag SS	PVDF	130	0.50	0.50	each
78325-54	Style 259 tips	-	PVDF	40	0.50	0.50	set
78325-26D	Style 259	Anti-Acid/Anti-Mag SS	Delrin	130	0.50	0.50	each

### Plastic Replaceable Tip Tweezers (continued)

#### III Style 272

Plastic replaceable tip tweezers with strong, pointed tips.



Catalog No.	Style	Material	Tip Material	OAL mm	A mm	B mm	Pkg.
78325-272	Style 272	Anti-Acid/Anti-Mag SS	Carbon fiber	130	0.70	3.00	each
78325-54C	Style 272 tips	-	Carbon fiber	40	0.70	3.00	set

#### III Style 277

Plastic replaceable tip tweezers with strong, pointed tips.



Catalog No.	Style	Material	Tip Material	OAL mm	A mm	B mm	Pkg.
78325-277	Style 277	Anti-Acid/Anti-Mag SS	Carbon fiber	130	0.70	3.00	each
78325-54CF	Style 277 tips	-	Carbon fiber	40	0.70	3.00	set

#### III Style 279

Plastic replaceable tip tweezers with strong, pointed tips.



Catalog No.	Style	Material	Tip Material	OAL mm	A mm	B mm	Pkg.
78325-279	Style 279	Anti-Acid/Anti-Mag SS	Carbon fiber	130	1.15	2.00	each
78325-55C	Style 279 tips	-	Carbon fiber	40	1.15	2.00	set

#### III Style 2WF

Plastic replaceable tip tweezers with handling 2", fine, round, strong top fingers, stepped bottom paddle.



Catalog No.	Style	Material	Tip Material	OAL mm	A mm	B mm	Pkg.
78325-33	Style 2WF	Anti-Acid/Anti-Mag SS	PVDF	130	0.50	6.60	each
78325-60	Style 2WF tips	-	PVDF	40	0.50	6.60	set

#### III Style 4WF

Plastic replaceable tip tweezers with handling 4", flat round, stepped bottom paddle.



Catalog No.	Style	Material	Tip Material	OAL mm	A mm	B mm	Pkg.
4WFCPR.SA	Style 4WF	Anti-Acid/Anti-Mag SS	Carbon PEEK	130	1.00	12.00	each
A4WFCP	Style 4WF tips	-	Carbon PEEK	40	1.00	12.00	set
78325-36	Style 4WF	Anti-Acid/Anti-Mag SS	PVDF	130	1.00	12.00	each
78325-62	Style 4WF tips	-	PVDF	40	1.00	12.00	set

#### III Plastic Replaceable Tip Tweezer Kit

5 tips, one tweezer — Carbon Fiber.

Includes tip styles: 249, 7, 5, 259, and 2A.

Encased in a top quality hard/foam wallet.

Catalog No.	Description	Pkg.
78325-42	Plastic Replaceable Tip Tweezer Kit	kit





EMS LINE OF TWEEZERS

Ceramic Replaceable Tip Tweezers

Zirconia ceramic precision tips (MZ) and ESD ceramic precision tips (ZJ). Contamination free, high temperature (1400°C) wear and solder resistant. Stainless steel (SA) handles. PATENT PENDING NO. 1750/97, Alignable replaceable tips.

- Zirconia Toughened Alumina (ZTA)
- A superior combination of high strength (from zirconia) and high hardness (from alumina)
- Relatively low density
- No open porosity
- Very hard surface, good abrasion and wear resistance
- Good flexural strength and fracture toughness
- Excellent thermal properties and high temperature stability
- Extreme corrosion resistance, nearly chemically inert
- Typical applications include soldering processes and handling of components during thermal and chemical processes.
- Available in ESD safe static dissipative material for handling of EOS/ESD sensitive components and in electrically insulating ceramic.

III Style 2A

Ceramic replaceable tip tweezers with flat duckbill tips

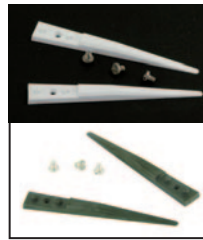

Catalog No.	Style	Material	Tip Material	OAL mm	A mm	B mm	Pkg.
78127-2A	Style 2A	Anti-Acid/Anti-Mag SS	Ceramic	140	0.30	2.00	each
78127-2A-T	Style 2A tips	-	Ceramic	50	0.30	2.00	each
2AZJK.SA	Style 2A	Anti-Acid/Anti-Mag SS	ESD Ceramic	130	0.30	2.00	each
A2AZJK	Style 2A tips	-	ESD Ceramic	40	0.30	2.00	each

III Style 71

Ceramic replaceable tip tweezers with thin, fine tips

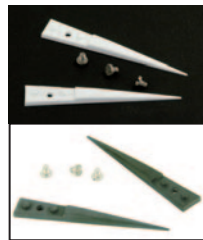

Catalog No.	Style	Material	Tip Material	OAL mm	A mm	B mm	Pkg.
78127-71	Style 71	Anti-Acid/Anti-Mag SS	Ceramic	135	0.45	0.70	each
78325-71-RT	Style 71 tips	-	Ceramic	45	0.45	0.70	each
71ZJ.SA	Style 71	Anti-Acid/Anti-Mag SS	ESD Ceramic	135	0.45	0.70	each
A71ZJ	Style 71 tips	-	ESD Ceramic	45	0.45	0.70	each

III Style 72

Ceramic replaceable tip tweezers with strong, pointed tips



Catalog No.	Style	Material	Tip Material	OAL mm	A mm	B mm	Pkg.
72MZ.SA	Style 72	Anti-Acid/Anti-Mag SS	Ceramic	135	0.35	0.40	each
78127-72-T	Style 72 tips	-	Ceramic	45	0.35	0.40	each
72ZJ.SA	Style 72	Anti-Acid/Anti-Mag SS	ESD Ceramic	135	0.35	0.40	each
A72ZJ	Style 72 tips	-	ESD Ceramic	45	0.35	0.40	each

Ceramic Replaceable Tip Tweezers continued)

III Style 73

Ceramic replaceable tip tweezers with fine, pointed tips



78127-73

Catalog No.	Style	Material	Tip Material	OAL mm	A mm	B mm	Pkg.
78127-73	Style 73	Anti-Acid/Anti-Mag SS	Ceramic	140	0.50	0.30	each
78127-73-T	Style 73 tips	-	Ceramic	50	0.50	0.30	each

III Style 74

Ceramic replaceable tip tweezers with straight, fine, pointed, strong tips.



78127-74

Catalog No.	Style	Material	Tip Material	OAL mm	A mm	B mm	Pkg.
78127-74	Style 74	Anti-Acid/Anti-Mag SS	Ceramic	140	1.00	1.00	each
78127-74-T	Style 74 tips	-	Ceramic	40	1.00	1.00	each

III Style 7

Ceramic replaceable tip tweezers with fine, curved tips



78127-7

Catalog No.	Style	Material	Tip Material	OAL mm	A mm	B mm	Pkg.
78127-7	Style 7	Anti-Acid/Anti-Mag SS	Ceramic	130	0.45	0.70	each
78127-7-T	Style 7 tips	-	Ceramic	40	0.45	0.70	each

Full Ceramic Tweezers

Partially stabilized zirconia (PSZ)

Made from Zirconia, which has a superior combination of high strength and flexibility. Full ceramic tweezers are suitable for handling of EOS/ESD sensitive components, handling of components during thermal, chemical and soldering processes.

- Both hard and fracture tough
- Fine grain size: excellent surface finish able to hold sharp edge
- Relatively low density
- No open porosity
- Good abrasion and wear resistance
- Superior flexural strength and fracture toughness
- Good thermal properties and good temperature stability
- Extreme corrosion resistance, nearly chemically inert
- Electrically insulative until 400-500°C

III Style 00, serrated tips

Ceramic tweezer with straight, line serrated tips. Length 125mm.



Catalog No.	Material	A mm	B mm	Pkg.
78126	Ceramic	0.80	1.00	each

III Style 3

Ceramic tweezer with squared, flat tips. Length 125mm.



Catalog No.	Material	A mm	B mm	Pkg.
78122	Ceramic	0.40	1.00	each

III Style 7

Ceramic tweezer with curved, squared, flat tips. Length 125mm.



Catalog No.	Material	A mm	B mm	Pkg.
78120	Ceramic	0.60	0.50	each

III Style 00

Ceramic tweezer with straight tips. Length 125mm.



Catalog No.	Material	A mm	B mm	Pkg.
78124	Ceramic	0.80	1.00	each

EMS LINE OF TWEEZERS

Full Plastic Tweezers

High precision plastic tweezers are available in Carbon Fiber, Polyvinylidene fluoride carbon fiber reinforced (PVDF), and Delrin.

**Carbon Fiber Tweezers** are best for sensitive electronic components, micro-mechanical parts, glass and ceramic substrates, capillary.

- PA66/CF30 polyamide 66 reinforced with 30 wt% carbon fiber
- Heat stabilized, good heat capability
- Very high rigidity, excellent tensile and flexural strength, fatigue and creep resistance
- Low friction, self lubricating properties, excellent wear resistance
- Good chemical resistance (oils, grease, fuels, non polar solvents); not resistant to strong acids, alkalis and hot water or steam
- ESD safe material, (avoid powder attraction, sparks generation, ignition sources).
- Very low coefficient of linear thermal expansion

**PVDF Reinforced Tweezers** applications include handling of very scratch- and contamination-sensitive components, cleaning and etching processes.

- Heat stabilized, high heat capability, continuous use up to 150°C
- Clean room and medical devices approved, low extraction value
- Excellent chemical resistance to mineral and organic acids, and solvents (hydrocarbons, alcohols, halogenated), resistant to halogens
- Outstanding resistance to hydrofluoric acid (40% conc., 90°C), nitric acid (50% conc., 90°C), hydrochloric acid (36% conc., 90°C)
- High abrasion resistant
- Resistant to UV and nuclear radiation (sterilization)
- ESD safe material, (avoid powder attraction, spark and ignition sources)

**Delrin Tweezer** applications include handling of very scratch sensitive components (ceramic and glass devices, wafers, capillary)

- POM/GF30 acetal resin reinforced with 30 wt% glass fiber
- Good tensile and flexural strength, fatigue and creep resistance
- Low friction, good wear and abrasion resistance
- Low moisture absorption
- Good chemical resistance (oils, grease, fuels, organic solvents); not resistant to strong acids, alkalis and oxidizing agents; good hydrolytic resistance (hot water)
- Insulating

III Style 702A

Full plastic tweezers with flat duckbill tips. OAL 115mm.

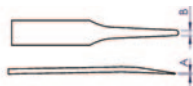

Catalog No.	Material	ESD Safe	A mm	B mm	Pkg.
78460-702A-C	Carbon fiber	Yes	0.50	2.00	each
78460-702A	PVDF	Yes	0.50	2.00	each
78460-702A-D	Delrin	No	0.50	2.00	each

III Style 705

Full plastic tweezers with fine, sharp tips. OAL 115mm.

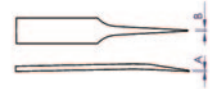

Catalog No.	Material	ESD Safe	A mm	B mm	Pkg.
78460-705-C	Carbon fiber	Yes	0.50	0.50	each
78460-705	PVDF	Yes	0.50	0.50	each
78460-705-D	Delrin	No	0.50	0.50	each

III Style 707

Full plastic tweezers with fine, sharp tips. OAL 115mm.

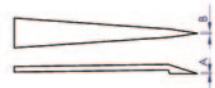

Catalog No.	Material	ESD Safe	A mm	B mm	Pkg.
78460-707-C	Carbon fiber	Yes	0.70	0.50	each
78460-707	PVDF	Yes	0.70	0.50	each
78460-707-D	Delrin	No	0.70	0.50	each

III Style 707A

Carbon fiber tweezers with curved, angled, pointed, short tips. OAL 115mm.



Catalog No.	Material	ESD Safe	A mm	B mm	Pkg.
78460-707A-C	Carbon fiber	Yes	0.50	0.60	each
78460-707A-P	PVDF	Yes	0.50	0.60	each
78460-707A-D	Delrin	No	0.50	0.60	each

III Style 708

Full plastic tweezers with bent, angled, very fine, short tips. OAL 110mm.



Catalog No.	Material	ESD Safe	A mm	B mm	Pkg.
78460-708-C	Carbon fiber	Yes	0.50	0.50	each
78460-708	PVDF	Yes	0.50	0.50	each
78460-708-D	Delrin	No	0.50	0.50	each

Full Plastic Tweezers (continued)

III Style 709

Full plastic tweezers with angled, squared, short, flat tips. OAL 115mm.



Catalog No.	Material	ESD Safe	A mm	B mm	Pkg.
78460-709-C	Carbon fiber	Yes	0.30	3.30	each
78460-709	PVDF	Yes	0.30	3.30	each
78460-709	Delrin	No	0.30	3.30	each

III Style 710

Full plastic tweezers with angled, squared, flat, trapezoidal shape tips. OAL 115mm.



Catalog No.	Material	ESD Safe	A mm	B mm	Pkg.
78460-710-C	Carbon fiber	Yes	0.30	7.70	each
78460-710	PVDF	Yes	0.30	7.70	each
710.DG	Delrin	No	0.30	7.70	each

III Full Plastic Tweezer Kits

Kit of 4 Carbon Fiber Tweezers

Styles 707, 708, 709, 710. ESD safe.

Catalog No.	Description	Pkg.
78460-02	EMS Fiber Tweezers, 4 Carbon fiber	kit



Kit of 5 Carbon Fiber Tweezers

Styles 702A, 707, 708, 709, 710. ESD safe.

Catalog No.	Description	Pkg.
78460-03	EMS Fiber Tweezers, 5 Carbon fiber	kit



Kit of 5 PVDF Tweezers

Styles 702A, 707, 708, 709, 710. ESD safe.

Catalog No.	Description	Pkg.
78460-04	EMS Fiber Tweezers, 5 PVDF	kit

Kit of 6 Carbon Fiber Tweezers

Styles 702A, 705, 707, 708, 709, 710. ESD safe.

Catalog No.	Description	Pkg.
78460-05	EMS Fiber Tweezers, 6 Carbon fiber	kit



Kit of 6 PVDF Tweezers

Styles 702A, 705, 707, 708, 709, 710. ESD safe.

Catalog No.	Description	Pkg.
78460-06	EMS Fiber Tweezers, 6 PVDF	kit

III EMS Carbon Fiber Soft Tip Tweezers

The EMS carbon fiber soft tip tweezers feature scratch resistant carbon fiber tips, specially designed to handle sensitive objects. The body is made from low carbon austenitic, non-magnetic stainless steel. The tips are corrosion resistant to moderately aggressive chemicals, salts and acids. Optimal working temperatures are up to 350°C (662°F). For short term use, maximum temperature should not exceed 925°C (1,697°F). Typical applications include handling of sensitive and electronic components, soft materials, micro-mechanical parts, glass, quartz, ceramics and silicon wafers. The tweezers body is made from non-magnetic stainless steel. ESD safe.

III Style 51

Flat Carbon Fiber Soft Tip Tweezers. Length: 110mm, Tips (Width): 10mm



Catalog No.	Style	Pkg.
78751-01	EMS Flat Carbon Fiber Soft Tip Style 51	each

III Style 52

Spade Carbon Fiber Soft Tip Tweezers. Length: 110mm, Tips (Width): 6mm

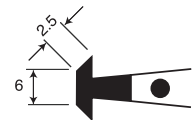

Catalog No.	Style	Pkg.
78751-02	EMS Spade Carbon Fiber Soft Tip Style 52	each

III Style 53

Angled Carbon Fiber Soft Tip Tweezers. Length: 110mm, Tips (Width): 2.50mm

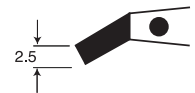

Catalog No.	Style	Pkg.
78751-03	EMS Angled Carbon Fiber Soft Tip Style 53	each

III Style 542

Triangle Carbon Fiber Soft Tip Tweezers. Length: 110mm, Tips (Width): 2 x 2 x 2mm

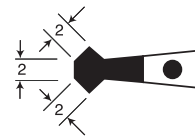

Catalog No.	Style	Pkg.
78751-04	EMS Triangle Carbon Fiber Soft Tip Style 54	each

## DUMONT TWEEZERS

## Overview

## Dumont: Fine and Accurate Tweezers

Developed in 1875 by Arnold Dumont in La Sagne, Switzerland. Dumont produces high quality handmade tweezers, and has gained the popularity of all researchers over the years. There is a variety of material which is used to make Dumont tweezers, as is shown in the list below:

**Biological Grade**

Made from Dumoxel steel, the highest quality steel that is available. These tweezers have very fine points, they are non-magnetic, and anti-corrosive. They are the most reliable for all of your precision work.

**High Precision Grade**

Made from (Inox) stainless steel, these tweezers have fine points and they can be used as a substitute for Biological Grade when non-magnetic tweezers are not required.

**Epoxy Coated**

Made from non-magnetic steel with an epoxy covered handle (tips are not coated); ideal for working in conductive environments.

**Medical Grade**

These tweezers are made from stainless steel and they are anti-magnetic and come with a clamping ring, which slides easily into a locking or release position. The tweezers have serrated handles.

**Carbon Steel** is an extremely hard alloy (> 59 HRC) composed of C, Mn, and Si. While Carbon ensures strong tips, it will nevertheless easily rust. This alloy is magnetic and cannot be sterilized.

**Inox 02** is a standard magnetic stainless steel composed of C, Mn, Cr and Si. This alloy is not as hard as carbon steels because it contains Chromium. Inox 02 will resist temperatures of around 400°C (DIN 50 914), but cannot be sterilized.

**Inox 08** is a medical stainless steel composed of C, Mn, Cr, Mo and V that provides an excellent resistance to corrosion and a good resistance to salt. Although not as hard as Carbon steels, Inox 08 offers excellent resistance to corrosion. This magnetic alloy supports temperatures of around 400°C (DIN 50914) and is suitable for autoclave sterilization at 180°C.

**Dumoxel** is composed of C, Cr, Ni, Mo and Cu and is the most popular alloy among our customers. This alloy was developed and patented by Dumont to offer the best in resistance to corrosion thanks to its high concentration of molybdenum and chromium. Dumoxel also guarantees an excellent resistance to sulphuric environments, hydrochloric acid, as well as to all other mineral and organic acids. Dumoxel is 95% antimagnetic, resistant up to temperatures of around 400° C (DIN 50 914) and is suitable for autoclave sterilization at 270°C.

**Dumostar** — This Dumont patented alloy is composed of C, Cr, Mo, Mn, Co, Ni and Si. Dumostar is more elastic and more resistant to corrosion than the best stainless steels. It is also perfectly compatible with human tissues and is resistant to mineral and organic acids as well to salt. Although slightly more expensive than other alloys, Dumostar is 100% antimagnetic and is resistant to sterilization temperatures of up to 500°C. This is the most cost effective and appropriate alloy for laboratory use.

**Antimagnetic** is composed of C, Cr, Ni and Mo. It offers a good resistance to corrosion thanks to its high concentration of molybdenum and is 80% antimagnetic but is not as hard as Inox. Antimagnetic is resistant up to temperatures of around 400°C (DIN 50 914) and is suitable for autoclave sterilization at 270°C.

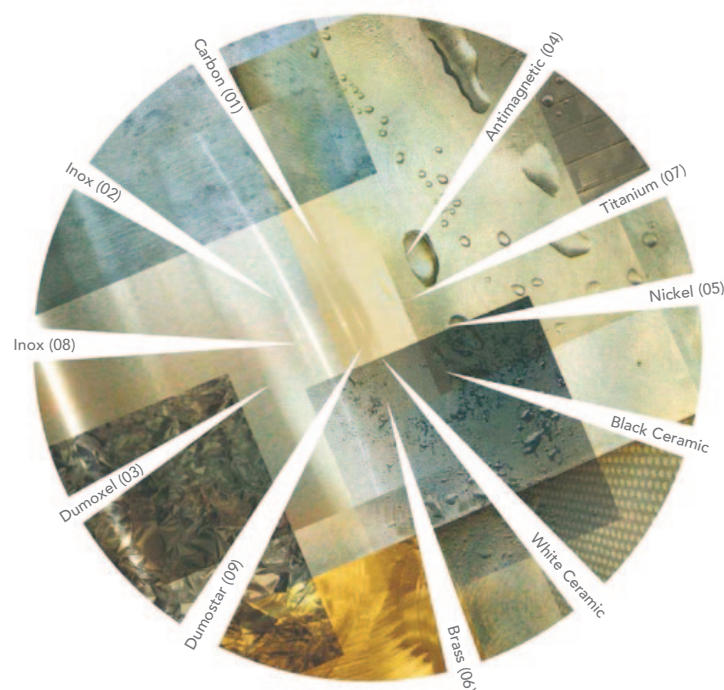
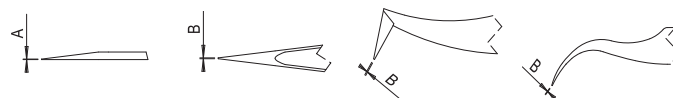
**TIP DIMENSION GUIDE:**

**Titanium** is an alloy composed of C, Fe, O, H, N and Ti. It is totally resistant to corrosion from nitric acid, chloride, salt water, and the like. This alloy is not as hard as Inox 08 but is 40% lighter and more flexible. Titanium 100% antimagnetic and resistant up to temperatures of around 430°C.

**Nickel** is a 100% antimagnetic alloy composed of Cu, Ni, Mn and Zn. It is widely appreciated as it does not damage the components handled by it.

**Black Ceramic** — Ceramic ZrO<sub>2</sub> is even harder than stainless steel and does not contain carbon or other metal additives. It offers good resistance to chemicals and is Electro Static Discharge safe. Black Ceramic is antimagnetic (Zero residual magnetism) and microwave-sterilization compatible. It does not produce metallic contamination and offers good thermal isolation for soldering; solder will not adhere to its surface. Black ceramic is clean room safe and is available in antistatic versions for CMOS.

**White Ceramic** — Ceramic ZrO<sub>2</sub> is even harder than stainless steel and does not contain carbon or other metal additives. It offers good resistance to chemicals and is Electro Static Discharge safe. White Ceramic is antimagnetic (Zero residual magnetism) and microwave-sterilization compatible. It does not produce metallic contamination and offers good thermal isolation for soldering; solder will not adhere to its surface. White ceramic is clean room safe and is available in anti-static versions for CMOS.

**Brass** is composed of Cu, Pb, Sn, Ni and Zn. This alloy is 100% antimagnetic and is widely used for handling delicate components, especially in watch-making.

## Standard, Biological, and Electronic Grade – POSITIVE ACTION

## STRAIGHT STYLES

## III Style 0

Geneva pattern, thin tips



Cat. #	OAL mm	A mm	B mm	Grade	Finish	Alloy	Unit
0103-0-PO	115	0.1	0.17	High Precision	Polished	Dumoxel®	each
0203-0-PO	115	0.04	0.08	Biological	Polished	Dumoxel®	each
0208-0-PO	115	0.04	0.08	Biological	Polished	Inox 8	each
0302-0-PO	115	0.1	0.17	Electronic	Polished	Inox 2	each
0304-0-CO	115	0.1	0.17	Electronic	Epoxy Coated	Antimagnetic	each

## III Style 00

Geneva pattern, strong tips, heavy body.



Cat. #	OAL mm	A mm	B mm	Grade	Finish	Alloy	Unit
0103-00-PO	115	0.25	0.45	High Precision	Polished	Dumoxel®	each
0302-00-CO	115	0.25	0.45	Electronic	Epoxy Coated	Inox 02	each
0304-00-CO	115	0.25	0.45	Electronic	Epoxy Coated	Antimagnetic	each

## III Style 00C

Geneva pattern, strong tips, short shanks.



Cat. #	OAL mm	A mm	B mm	Grade	Finish	Alloy	Unit
0102-00C-PO-1	105	0.25	0.45	High Precision	Polished	Inox 02	each
0101-00C-PO-1	105	0.25	0.45	High Precision	Polished	Carbon	each
0302-00C-PO-1	105	0.25	0.45	Electronic	Polished	Inox 02	each

## III Style 0A

Thin tips



Cat. #	OAL mm	A mm	B mm	Grade	Finish	Alloy	Unit
0102-0A-PO-1	120	0.08	0.13	High Precision	Polished	Inox 02	each
0103-0A-PO-1	120	0.08	0.13	High Precision	Polished	Dumoxel®	each
0101-0A-PO-1	120	0.06	0.1	High Precision	Polished	Carbon	each

## III Style 0C100

Geneva pattern



Cat. #	OAL mm	A mm	B mm	Grade	Finish	Alloy	Unit
0102-0C100-PO-1	100	0.17		High Precision	Polished	Inox 02	each
0101-0C100-PO-1	100	0.08	0.13	High Precision	Polished	Carbon	each
0302-0C100-CO-1	100	0.1	0.17	Electronic	Epoxy Coated	Inox 02	each
0302-0C100-PO-1	100	0.1	0.17	Electronic	Polished	Inox 02	each
0304-0C100-PO-1	100	0.1	0.17	Electronic	Polished	Antimagnetic	each

## III Style 0C90

Geneva pattern



Cat. #	OAL mm	A mm	B mm	Grade	Finish	Alloy	Unit
0101-0C90-PO-1	90	0.08	0.13	High Precision	Polished	Carbon	each
0102-0C90-PO-1	90	0.1	0.17	High Precision	Polished	Inox 02	each
0302-0C90-CO-1	90	0.1	0.17	Electronic	Epoxy Coated	Inox 02	each
0302-0C90-PO-1	90	0.1	0.17	Electronic	Polished	Inox 02	each
0304-0C90-PO-1	90	0.1	0.17	Electronic	Polished	Antimagnetic	each

## III Style 1

Strong tips.



Cat. #	OAL mm	A mm	B mm	Grade	Finish	Alloy	Unit
0103-1-PO	120	0.12	0.2	High Precision	Polished	Dumoxel®	each
0109-1-PO	120	0.12	0.2	High Precision	Polished	Dumostar®	each
0102-1-PO-1	120	0.12	0.2	High Precision	Polished	Inox 02	each
0101-1-PO-1	120	0.1	0.17	High Precision	Polished	Carbon	each
0107-1TI-PO-1	120	0.12	0.2	High Precision	Polished	Titanium	each
0302-1-PO	120	0.12	0.2	Electronic	Polished	Inox 02	each
0304-1-CO	120	0.12	0.2	Electronic	Epoxy Coated	Antimagnetic	each
0304-1-PO-1	120	0.12	0.2	Electronic	Polished	Antimagnetic	each

## DUMONT TWEEZERS

## Standard, Biological, and Electronic Grade – POSITIVE ACTION

STRAIGHT STYLES *continued*

## III Style 1AM

Strong tips. Very popular in watch-making.

Cat. #	OAL mm	A mm	B mm	Grade	Finish	Alloy	Unit
5306-1AM-PS-1	120	0.12	0.2	High Precision	Matte	Brass	each



## III Style 1L

Strong, flat round tips with inside chamfer.

Cat. #	OAL mm	A mm	B mm	Grade	Finish	Alloy	Unit
5306-1L-PS-1	125	0.2	2	High Precision	Matte	Brass	each



## III Style 2

Strong long tips

Cat. #	OAL mm	A mm	B mm	Grade	Finish	Alloy	Unit
0103-2-PO	120	0.14	0.34	High Precision	Polished	Dumoxel®	each
0109-2-PO	120	0.14	0.34	High Precision	Polished	Dumostar®	each
0102-2-PO-1	120	0.14	0.34	High Precision	Polished	Inox 02	each
0101-2-PO-1	120	0.12	0.3	High Precision	Polished	Carbon	each
0105-2NI-PO-1	120	0.14	0.34	High Precision	Polished	Nickel	each
0208-2SP-PO-1	120	0.02	0.4	Biological	Polished	Inox 08	each
3308-2-PO-1	120	0.07	0.17	Biological	Polished	Inox 08	each
0303-2-PO	120	0.14	0.34	Electronic	Polished	Dumoxel®	each
0302-2-CO	120	0.14	0.34	Electronic	Epoxy Coated	Inox 02	each
0304-2-CO	120	0.14	0.34	Electronic	Epoxy Coated	Antimagnetic	each
0302-2-PO-1	120	0.14	0.34	Electronic	Polished	Inox 02	each
0304-2-PO-1	120	0.14	0.34	Electronic	Polished	Antimagnetic	each



## III Style 2A

Flat round tips.

Cat. #	OAL mm	A mm	B mm	Grade	Finish	Alloy	Unit
0103-2A-PO	120	0.2	1.5	High Precision	Polished	Dumoxel®	each
0109-2A-PO	120	0.2	1.5	High Precision	Polished	Dumostar®	each
0102-2A-PO-1	120	0.2	1.5	High Precision	Polished	Inox 02	each
0101-2A-PO-1	120	0.2	1.5	High Precision	Polished	Carbon	each
0303-2A-PO	120	0.2	1.5	Electronic	Polished	Dumoxel®	each
0302-2A-CO	120	0.2	1.5	Electronic	Epoxy Coated	Inox 02	each
0302-2A-PO-1	120	0.2	1.5	Electronic	Polished	Inox 02	each
0304-2A-CO	120	0.2	1.5	Electronic	Epoxy Coated	Antimagnetic	each
0304-2A-PO-1	120	0.2	1.5	Electronic	Polished	Antimagnetic	each



## III Style 2AM

Strong tips with bevel. Length: 120mm

Cat. #	OAL mm	A mm	B mm	Grade	Finish	Alloy	Unit
5306-2AM-PS-1	0.14	0.34		High Precision	Matte	Brass	each



## III Style 2L

Special tips, mirror finished inside.

Cat. #	OAL mm	A mm	B mm	Grade	Finish	Alloy	Unit
5306-2L-PS-1	111	0.2	0.2	High Precision	Matte	Brass	each



## Standard, Biological, and Electronic Grade – POSITIVE ACTION

STRAIGHT STYLES *continued*

## III Style 3

Thin tips.



Cat. #	OAL mm	A mm	B mm	Grade	Finish	Alloy	Unit
0103-3-PO	120	0.1	0.17	High Precision	Polished	Dumoxel®	each
0109-3-PO	120	0.1	0.17	High Precision	Polished	Dumostar®	each
0102-3-PO-1	120	0.1	0.17	High Precision	Polished	Inox 02	each
0101-3-PO-1	120	0.08	0.13	High Precision	Polished	Carbon	each
0106-3-PO-1	120	0.1	0.17	High Precision	Polished	Brass	each
0208-3-PO	120	0.04	0.08	Biological	Polished	Inox 08	each
72690-D	120	0.04	0.08	Biological	Polished	Dumoxel®	each
72690-DZ	120	0.04	0.08	Biological	Polished	Dumoxel®	doz
72693-01	120	0.04	0.08	Biological	Polished	Dumostar®	each
72693-12	120	0.04	0.08	Biological	Polished	Dumostar®	doz
72691-D	120	0.1	0.17	Biological	Polished Serration	Inox 08	each
72691-DZ	120	0.1	0.17	Biological	Polished	Inox 08	doz
0303-3-PO	120	0.1	0.17	Electronic	Polished	Dumoxel®	each
0302-3-PO	120	0.1	0.17	Electronic	Polished	Inox 02	each
0302-3-CO-1	120	0.1	0.17	Electronic	Epoxy Coated	Inox 02	each
72692-D	120	0.1	0.17	Electronic	Epoxy Coated	Antimagnetic	each
72692-DZ	120	0.1	0.17	Electronic	Epoxy Coated	Antimagnetic	doz
0304-3-PO-1	120	0.1	0.17	Electronic	Polished	Antimagnetic	each
0304-3-TF-1	120	0.1	0.17	Electronic	PTFE Coated	Antimagnetic	each
0306-3-CO-1	120	0.1	0.17	Electronic	Epoxy Coated	Brass	each

## III Style 3AM

Thin tips.



Cat. #	OAL mm	A mm	B mm	Grade	Finish	Alloy	Unit
5306-3AM-PS-1	120	0.1	0.17	High Precision	Matte	Brass	each

## III Style 3C

Type 3 short, thin tips.



Cat. #	OAL mm	A mm	B mm	Grade	Finish	Alloy	Unit
0103-3C-PO	110	0.1	0.17	High Precision	Polished	Dumoxel®	each
0109-3C-PO	110	0.1	0.17	High Precision	Polished	Dumostar®	each
0102-3C-PO-1	110	0.1	0.17	High Precision	Polished	Inox 02	each
72684-01	110	0.1	0.17	High Precision	Polished	Inox 08	each
0106-3C-PO-1	110	0.1	0.17	High Precision	Polished	Brass	each
0107-3CTI-PO-1	110	0.1	0.17	High Precision	Polished	Titanium	each
0101-3C-PO-1	110	0.08	0.13	High Precision	Polished	Carbon	each
72680-D	110	0.04	0.08	Biological	Polished	Dumoxel®	each
72680-DZ	110	0.04	0.08	Biological	Polished	Dumoxel®	doz
72683-01	110	0.04	0.08	Biological	Polished	Dumostar®	each
72683-12	110	0.04	0.08	Biological	Polished	Dumostar®	doz
72681-D	110	0.04	0.08	Biological	Polished	Inox 08	each
72681-DZ	110	0.04	0.08	Biological	Polished	Inox 08	doz
72684-12	110	0.1	0.17	Biological	Polished	Inox 08	doz
72682-DZ	110	0.1	0.17	Biological	Epoxy Coated	Antimagnetic	doz
0303-3C-PO	110	0.1	0.17	Electronic	Polished	Dumoxel®	each
72682-D	110	0.1	0.17	Electronic	Epoxy Coated	Antimagnetic	each
0302-3C-CO-1	110	0.1	0.17	Electronic	Epoxy Coated	Inox 02	each
0302-3C-PO-1	110	0.1	0.17	Electronic	Polished	Inox 02	each



## DUMONT TWEEZERS

Standard, Biological, and Electronic Grade – POSITIVE ACTION

STRAIGHT STYLES *continued*

## III Style 4

Strong thin tips.



Cat. #	OAL mm	A mm	B mm	Grade	Finish	Alloy	Unit
0103-4-PO	110	0.08	0.13	High Precision	Polished	Dumoxel®	each
0109-4-PO	110	0.08	0.13	High Precision	Polished	Dumostoar	each
72696-D	110	0.1	0.17	High Precision	Polished	Inox 2	each
72696-DZ	110	0.1	0.17	High Precision	Polished	Inox 2	doz
0101-4-PO-1	110	0.06	0.1	High Precision	Polished	Carbon	each
0102-4-PO-1	110	0.08	0.13	High Precision	Polished	Inox 02	each
0109-4-PS-1	110	0.08	0.13	High Precision	Matte	Dumostar®	each
5306-4-PS-1	110	0.08	0.13	High Precision	Matte	Brass	each
72695-D	110	0.02	0.06	Biological	Polished	Dumoxel®	each
72695-DZ	110	0.02	0.06	Biological	Polished	Dumoxel®	doz
0209-4-PO	110	0.02	0.06	Biological	Polished	Dumostar®	each
0508-4-PO	110	0.08	0.13	Biological	Polished Serration	Inox 8	each
0303-4-PO	110	0.08	0.13	Electronic	Polished	Dumoxel®	each
0302-4-PO	110	0.08	0.13	Electronic	Polished	Inox 02	each
0302-4-CO-1	110	0.08	0.13	Electronic	Epoxy Coated	Inox 02	each
0304-4-CO	110	0.08	0.13	Electronic	Epoxy Coated	Antimagnetic	each
0304-4-PO-1	110	0.08	0.13	Electronic	Polished	Antimagnetic	each

## III Style 4TM

Thin TM tips with special shape.



Cat. #	OAL mm	A mm	B mm	Grade	Finish	Alloy	Unit
01708-4TM-PO-1	110	0.02	0.06	Biological	Polished	Inox 08	each

## III Style 5

Super thin tips.



Cat. #	OAL mm	A mm	B mm	Grade	Finish	Alloy	Unit
0103-5-PO	110	0.06	0.1	High Precision	Polished	Dumoxel®	each
0103-5-TF	110	0.06	0.1	High Precision	PTFE Coated	Dumoxel®	each
72706-01	110	0.06	0.1	High Precision	Polished	Dumostar®	each
72706-12	110	0.06	0.1	High Precision	Polished	Dumostar®	doz
0109-5-PS-1	110	0.06	0.1	High Precision	Matte	Dumostar®	each
0103-5-PS-1	110	0.06	0.1	High Precision	Matte	Dumoxel®	each
0102-5-TF-1	110	0.06	0.1	High Precision	PTFE Coated	Inox 02	each
0108-5-PO-1	110	0.06	0.1	High Precision	Polished	Inox 08	each
0108-5-PS-1	110	0.06	0.1	High Precision	Matte	Inox 08	each
0101-5-PO-1	110	0.04	0.08	High Precision	Polished	Carbon	each
72705-01	110	0.01	0.05	Biological	Polished	Dumostar®	each
72705-12	110	0.01	0.05	Biological	Polished	Dumostar®	doz
72700-D	110	0.01	0.05	Biological	Polished	Dumoxel®	each
72700-DZ	110	0.01	0.05	Biological	Polished	Dumoxel®	doz
0207-5TI-PO-1	110	0.01	0.05	Biological	Polished	Titanium	each
0207-5TI-PS-1	110	0.01	0.05	Biological	Matte	Titanium	each
0203-5-PS-1	110	0.01	0.05	Biological	Matte	Dumoxel®	each
0209-5-PS-1	110	0.01	0.05	Biological	Matte	Dumostar®	each
0208-5-PO-1	110	0.01	0.05	Biological	Polished	Inox 08	each
0208-5-PS-1	110	0.01	0.05	Biological	Matte	Inox 08	each
0508-5-PS-1	110	0.06	0.1	Biological	Matte	Inox 08	each
72701-01	110	0.06	0.1	Biological	Polished Serration	Inox 08	each
72701-12	110	0.06	0.1	Biological	Polished	Inox 08	doz
0302-5-CO	110	0.06	0.1	Electronic	Epoxy Coated	Inox 02	each
0302-5-PO	110	0.06	0.1	Electronic	Polished	Inox 02	each
72702-D	110	0.06	0.1	Electronic	Epoxy Coated	Antimagnetic	each
72702-DZ	110	0.06	0.1	Electronic	Epoxy Coated	Antimagnetic	doz
72702-DTIP	110	0.06	0.1	Electronic	PTFE Coated, Tip Coated	Antimagnetic	each
72702-DTIP-DZ	110	0.06	0.1	Electronic	PTFE Coated, Tip Coated	Antimagnetic	doz
0303-5-PO	110	0.06	0.1	Electronic	Polished	Dumoxel®	each
0303-5-TF	110	0.06	0.1	Electronic	PTFE Coated	Dumoxel®	each
0304-5-TF	110	0.06	0.1	Electronic	PTFE Coated	Antimagnetic	each
0302-5-PS-1	110	0.06	0.1	Electronic	Matte	Inox 02	each
0304-5-PO-1	110	0.06	0.1	Electronic	Polished	Antimagnetic	each
0304-5-PS-1	110	0.06	0.1	Electronic	Matte	Antimagnetic	each
0303-5-PS-1	110	0.06	0.1	Electronic	Matte	Dumoxel®	each

## Standard, Biological, and Electronic Grade – POSITIVE ACTION

**STRAIGHT STYLES** *continued***III Style 5XL**

Type 5, extra long, super thin tips, for large hands.



Cat. #	OAL mm	A mm	B mm	Grade	Finish	Alloy	Unit
0508-5XL-PO	150	0.06	0.1	Biological	Polished Serration	Inox 08	each

**III Style 5A**

Oblique tips



Cat. #	OAL mm	A mm	B mm	Grade	Finish	Alloy	Unit
0103-5A-PO-1	115	0.08	0.13	High Precision	Polished	Dumoxel®	each
0109-5A-PO-1	115	0.08	0.13	High Precision	Polished	Dumostar®	each
0109-5A-PS-1	115	0.08	0.13	High Precision	Matte	Dumostar®	each
0108-5A-PO-1	115	0.08	0.13	High Precision	Polished	Inox 08	each
0101-5A-PO-1	115	0.06	0.1	High Precision	Polished	Carbon	each
72720-D	115	0.01	0.05	Biological	Polished	Dumoxel®	each
72720-DZ	115	0.01	0.05	Biological	Polished	Dumoxel®	doz
0508-5A-PO	115	0.08	0.13	Biological	Polished Serration	Inox 8	each
0302-5A-PO-1	115	0.08	0.13	Electronic	Polished	Inox 02	each

**III Style 10B**

To curve center of hairsprings.



Cat. #	OAL mm	A mm	B mm	Grade	Finish	Alloy	Unit
0101-10B-PO-1	120	0.2	0.15	High Precision	Polished	Carbon	each

**III Style 11**

Strong tips. Ideal for manipulating delicate pieces.



Cat. #	OAL mm	A mm	B mm	Grade	Finish	Alloy	Unit
0105-11NI-PO-1	120	0.14	0.24	High Precision	Polished	Nickel	each
0105-11NI-PS-1	120	0.14	0.24	High Precision	Matte	Nickel	each
0305-11NI-CO	120	0.14	0.24	Electronic	Epoxy Coated	Nickel	each
0305-11NI-PO	120	0.14	0.24	Electronic	Polished	Nickel	each

**III Style 27**

Thin tips



Cat. #	OAL mm	A mm	B mm	Grade	Finish	Alloy	Unit
0103-27-PO-1	135	0.12	0.2	High Precision	Polished	Dumoxel®	each

**III Style 54**

Light, Super Fine.



Cat. #	OAL mm	A mm	B mm	Grade	Finish	Alloy	Unit
72709-D	110	0.02	0.06	Biological	Polished	Dumoxel®	each
72709-DZ	110	0.02	0.06	Biological	Polished	Dumoxel®	doz

**III Style 55**

Type 5, light shanks, very thin tips for hairsprings.



Cat. #	OAL mm	A mm	B mm	Grade	Finish	Alloy	Unit
0103-55-PO	110	0.08	0.13	High Precision	Polished	Dumoxel®	each
0102-55-PO-1	110	0.08	0.13	High Precision	Polished	Inox 02	each
0203-55-PO	110	0.01	0.05	Biological	Polished	Dumoxel®	each
0203-55-PS-1	110	0.01	0.05	Biological	Matte	Dumoxel®	each
72707-01	110	0.01	0.05	Biological	Polished	Dumostar®	each
72707-12	110	0.01	0.05	Biological	Polished	Dumostar®	doz
0209-55-PS-1	110	0.01	0.05	Biological	Matte	Dumostar®	each
0208-55-PO-1	110	0.01	0.05	Biological	Polished	Inox 08	each
0208-55-PS-1	110	0.01	0.05	Biological	Matte	Inox 08	each
0207-55TI-PO-1	110	0.01	0.05	Biological	Polished	Titanium	each

## DUMONT TWEEZERS

Standard, Biological, and Electronic Grade – POSITIVE ACTION

STRAIGHT STYLES *continued*

## III Style 60/3

To bend thin copper wires.

Cat. #	OAL mm	A mm	B mm	Grade	Finish	Alloy	Unit
0101-60/3-PO-1	115	0.5	0.65	High Precision	Polished	Carbon	each



## III Style A

Strong tips

Cat. #	OAL mm	A mm	B mm	Grade	Finish	Alloy	Unit
0102-A-PO-1	115	0.35	0.6	High Precision	Polished	Inox 02	each
0101-A-PO-1	115	0.35	0.6	High Precision	Polished	Carbon	each
0302-A-PO-1	115	0.35	0.6	Electronic	Polished	Inox 02	each



## III Style AA

Strong tips

Cat. #	OAL mm	A mm	B mm	Grade	Finish	Alloy	Unit
0103-AA-PO	125	0.2	0.4	High Precision	Polished	Dumoxel®	each
0102-AA-PO-1	125	0.2	0.4	High Precision	Polished	Inox 02	each
0303-AA-PO-1	125	0.2	0.4	Electronic	Polished	Dumoxel®	each
0302-AA-CO-1	125	0.2	0.4	Electronic	Epoxy Coated	Inox 02	each
0302-AA-PO-1	125	0.2	0.4	Electronic	Polished	Inox 02	each
0304-AA-CO-1	125	0.2	0.4	Electronic	Epoxy Coated	Antimagnetic	each
0304-AA-PO-1	125	0.2	0.4	Electronic	Polished	Antimagnetic	each



## III Style AC

Strong tips

Cat. #	OAL mm	A mm	B mm	Grade	Finish	Alloy	Unit
0102-AC-PO-1	105	0.35	0.6	High Precision	Polished	Inox 02	each
0101-AC-PO-1	105	0.35	0.6	High Precision	Polished	Carbon	each



## III Style F

Wide square tips.

Cat. #	OAL mm	A mm	B mm	Grade	Finish	Alloy	Unit
72814-D	120	0.2	2	High Precision	Polished	Dumoxel®	each
72814-DZ	120	0.2	2	High Precision	Polished	Dumoxel®	doz
0101-F-PO-1	120	0.2	2	High Precision	Polished	Carbon	each
0102-F-PO-1	120	0.2	2	High Precision	Polished	Inox 02	each
0304-F-PO-1	120	0.2	2	Electronic	Polished	Antimagnetic	each



## III Style GG

Strong and very precise

Cat. #	OAL mm	A mm	B mm	Grade	Finish	Alloy	Unit
72816-D	130	0.12	0.2	High Precision	Polished	Dumoxel®	each
72816-DZ	130	0.12	0.2	High Precision	Polished	Dumoxel®	doz



## III Style H

Triangle tips, short shanks.

Cat. #	OAL mm	A mm	B mm	Grade	Finish	Alloy	Unit
0103-H-PO	90	0.1	0.17	High Precision	Polished	Dumoxel®	each
0102-H-PO-1	90	0.1	0.17	High Precision	Polished	Inox 02	each
0101-H-PO-1	90	0.08	0.13	High Precision	Polished	Carbon	each
0302-H-CO-1	90	0.1	0.17	Electronic	Epoxy Coated	Inox 02	each
0304-H-PO-1	90	0.1	0.17	Electronic	Polished	Antimagnetic	each



## III Style P

Strong tips.

Cat. #	OAL mm	A mm	B mm	Grade	Finish	Alloy	Unit
0103-P-PO-1	120	0.14	0.24	High Precision	Polished	Dumoxel®	each
0102-P-PO-1	120	0.14	0.24	High Precision	Polished	Inox 02	each
0101-P-PO-1	120	0.12	0.2	High Precision	Polished	Carbon	each



## Standard, Biological, and Electronic Grade – POSITIVE ACTION

STRAIGHT STYLES *continued*

## III Style PP

Strong tips.

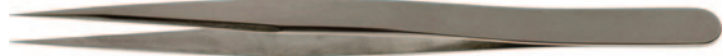

Cat. #	OAL mm	A mm	B mm	Grade	Finish	Alloy	Unit
0103-PP-PO-1	135	0.14	0.24	High Precision	Polished	Dumoxel®	each
0101-PP-PO-1	135	0.12	0.2	High Precision	Polished	Carbon	each
0508-PP-PO	135	0.14	0.24	Biological	Polished Serration	Inox 08	each
2408-PP-MF-1	135	0.06	0.1	Biological	Mirror polished	Inox 08	each
3308-PP-PS-1	135	0.06	0.1	Biological	Matte	Inox 08	each
3308-PP-PO-1	135	0.06	0.1	Biological	Polished	Inox 08	each

## III Style S

Thin tips.



Cat. #	OAL mm	A mm	B mm	Grade	Finish	Alloy	Unit
0103-S-PO-1	120	0.12	0.2	High Precision	Polished	Dumoxel®	each
0102-S-PO-1	120	0.12	0.2	High Precision	Polished	Inox 02	each
0101-S-PO-1	120	0.1	0.14	High Precision	Polished	Carbon	each

## III Style S5

Long popular tweezers for handling delicate parts.



Cat. #	OAL mm	A mm	B mm	Grade	Finish	Alloy	Unit
5305-S5-PO-1	130	0.3	0.2	High Precision	Polished	Nickel	each
5306-S5-PO	130	0.3	0.2	High Precision	Polished	Brass	each

## III Style SS

Long narrow shanks, thin tips



Cat. #	OAL mm	A mm	B mm	Grade	Finish	Alloy	Unit
72812-D	135	0.06	0.1	Biological	Polished	Dumoxel®	each
72812-DZ	135	0.06	0.1	Biological	Polished	Dumoxel®	doz

## III Style SS135

Long narrow shanks, thin tips



Cat. #	OAL mm	A mm	B mm	Grade	Finish	Alloy	Unit
0102-SS135-PO-1	135	0.12	0.2	High Precision	Polished	Inox 02	each
0103-SS135-PO-1	135	0.12	0.2	High Precision	Polished	Dumoxel®	each
0101-SS135-PO-1	135	0.1	0.14	High Precision	Polished	Carbon	each
0105-SS135NI-PO-1	135	0.12	0.2	High Precision	Polished	Nickel	each
0208-SS135-PS-1	135	0.06	0.1	Biological	Matte	Inox 08	each
0304-SS135-CO	135	0.12	0.2	Electronic	Epoxy Coated	Antimagnetic	each
0304-SS135-PO	135	0.12	0.2	Electronic	Polished	Antimagnetic	each

## III Style SS140

Long narrow shanks, thin tips



Cat. #	OAL mm	A mm	B mm	Grade	Finish	Alloy	Unit
0103-SS140-PO-1	140	0.12	0.2	High Precision	Polished	Dumoxel®	each
0109-SS140-PO-1	140	0.12	0.2	High Precision	Polished	Dumostar®	each
0102-SS140-PO-1	140	0.12	0.2	High Precision	Polished	Inox 02	each
0107-SS140TI-PO-1	140	0.12	0.2	High Precision	Polished	Titanium	each
0209-SS140-PO-1	140	0.06	0.1	Biological	Polished	Dumostar®	each
0304-SS140-CO-1	140	0.12	0.2	Electronic	Epoxy Coated	Antimagnetic	each
0304-SS140-PO-1	140	0.12	0.2	Electronic	Polished	Antimagnetic	each

III Plunging Tweezers for the CP3  
(Cryoplunge™ 3)

Custom tweezers specifically made to fit the Gatan Cryoplunge™ an instrument used in the preparation of frozen hydrated specimens for cryoEM.



Cat. #	Description	Unit
CP3690	Plunging Tweezers	each

## DUMONT TWEEZERS

## Standard, Biological, and Electronic Grade – POSITIVE ACTION

## CURVED &amp; ANGLED STYLES

## III Style 4AC

Anti-capillary, very thin tips.



Cat. #	OAL mm	A mm	B mm	Grade	Finish	Alloy	Unit
0208-4AC-PO	110	0.02	0.06	Biological	Polished	Inox 8	each

## III Style 5/15

Thin tips, bent 15 degrees.



Cat. #	OAL mm	A mm	B mm	Grade	Finish	Alloy	Unit
72708-D	105	0.06	0.1	High Precision	Polished	Dumoxel®	each
0103-5/15-PO	105	0.06	0.1	High Precision	Polished	Dumoxel®	each
72708-DZ	105	0.06	0.1	High Precision	Polished	Dumoxel®	doz
0101-5/15-PO-1	105	0.04	0.08	High Precision	Polished	Carbon	each
0203-5/15-PO	105	0.01	0.05	Biological	Polished	Dumoxel®	each
0203-5/15-PS-1	105	0.01	0.05	Biological	Matt	Dumoxel®	each
0208-5/15-PS-1	105	0.01	0.05	Biological	Matt	Inox 08	each
0304-5/15-PO	105	0.06	0.1	Electronic	Polished	Antimagnetic	each
0302-5/15-PO-1	105	0.06	0.1	Electronic	Polished	Inox 02	each

## III Style 5/45

Thin tips, bent 45 degrees.



Cat. #	OAL mm	A mm	B mm	Grade	Finish	Alloy	Unit
0103-5/45-PO-1	109	0.06	0.1	High Precision	Polished	Dumoxel®	each
0101-5/45-PO-1	109	0.04	0.08	High Precision	Polished	Carbon	each
72703-D	109	0.01	0.05	Biological	Polished	Dumoxel®	each
72703-DZ	109	0.01	0.05	Biological	Polished	Dumoxel®	doz
0203-5/45-PS-1	109	0.01	0.05	Biological	Matt	Dumoxel®	each
0208-5/45-PO	109	0.01	0.05	Biological	Polished	Inox 08	each
0208-5/45-PS-1	109	0.01	0.05	Biological	Matt	Inox 08	each
2408-5/45-MF-1	109	0.01	0.05	Biological	Mirror polished	Inox 08	each
0508-5/45-PO	109	0.06	0.1	Biological	Polished	Inox 08	each
0508-5/45-PS-1	109	0.06	0.1	Biological	Matte	Inox 08	each
3808-5/45-MF-1	109	0.06	0.1	Biological	Mirror polished	Inox 08	each
0302-5/45-PO-1	109	0.06	0.1	Electronic	Polished	Inox 02	each
0304-5/45-PO	109	0.06	0.1	Electronic	Polished	Antimagnetic	each

## III Style 5/90

Thin tips, bent 90 degrees.



Cat. #	OAL mm	A mm	B mm	Grade	Finish	Alloy	Unit
0103-5/90-PO-1	106	0.06	0.1	High Precision	Polished	Dumoxel®	each
0108-5/90-PO-1	106	0.06	0.1	High Precision	Polished	Inox 08	each
0101-5/90-PO-1	106	0.04	0.08	High Precision	Polished	Carbon	each
72704-D	106	0.01	0.05	Biological	Polished	Dumoxel®	each
72704-DZ	106	0.01	0.05	Biological	Polished	Dumoxel®	doz
0203-5/90-PS-1	106	0.01	0.05	Biological	Matte	Dumoxel®	each
0208-5/90-PO	106	0.01	0.05	Biological	Polished	Inox 08	each
0508-5/90-PO	106	0.06	0.1	Biological	Polished Serration	Inox 08	each
0208-5/90-PS-1	106	0.01	0.05	Biological	Matte	Inox 08	each
0508-5/90-PS-1	106	0.06	0.1	Biological	Matte	Inox 08	each
3808-5/90-MF-1	106	0.06	0.1	Biological	Mirror polished	Inox 08	each
2408-5/90-MF-1	106	0.01	0.05	Biological	Mirror polished	Inox 08	each
0302-5/90-PO	106	0.06	0.1	Electronic	Polished	Inox 02	each

## III Style 5TM

Oblique thin TM tips, with special shape.



Cat. #	OAL mm	A mm	B mm	Grade	Finish	Alloy	Unit
1708-5TM-PO-1	110	0.01	0.05	Biological	Polished	Inox 08	each

## Standard, Biological, and Electronic Grade – POSITIVE ACTION

CURVED & ANGLED STYLES *continued*

## III Style 5AC

Anti-capillary, very thin tips.



Cat. #	OAL mm	A mm	B mm	Grade	Finish	Alloy	Unit
72730-D	115	0.02	0.07	Biological	Polished	Dumoxel®	each
72730-DZ	115	0.02	0.07	Biological	Polished	Dumoxel®	doz
0208-5AC-PO	115	0.02	0.07	Biological	Polished	Inox 08	each
0208-5AC-PS-1	115	0.02	0.07	Biological	Matte	Inox 08	each
0207-5ACTI-PO-1	115	0.02	0.07	Biological	Polished	Titanium	each
0207-5ACTI-PS-1	115	0.02	0.07	Biological	Matte	Titanium	each

## III Style 6

Thin hooked tips.



Cat. #	OAL mm	A mm	B mm	Grade	Finish	Alloy	Unit
72750-D	115	0.1	0.17	High Precision	Polished	Dumoxel®	each
72750-DZ	115	0.1	0.17	High Precision	Polished	Dumoxel®	doz
0109-6-PO-1	115	0.1	0.17	High Precision	Polished	Dumostar®	each
0102-6-PO-1	115	0.1	0.17	High Precision	Polished	Inox 02	each
0101-6-PO-1	115	0.08	0.13	High Precision	Polished	Carbon	each
0203-6-PO	115	0.03	0.07	Biological	Polished	Dumoxel®	each
0203-6-PS-1	115	0.03	0.07	Biological	Matte	Dumoxel®	each
0208-6-PS-1	115	0.03	0.07	Biological	Matte	Inox 08	each
0207-6TI-PO-1	115	0.03	0.07	Biological	Polished	Titanium	each
0304-6-CO-1	115	0.1	0.17	Electronic	Epoxy Coated	Antimagnetic	each
0304-6-PO-1	115	0.1	0.17	Electronic	Polished	Antimagnetic	each

## III Style 7

Thin curved tips.



Cat. #	OAL mm	A mm	B mm	Grade	Finish	Alloy	Unit
0103-7-PO	115	0.1	0.17	High Precision	Polished	Dumoxel®	each
0109-7-PO	115	0.1	0.17	High Precision	Polished	Dumostar®	each
72804-01	115	0.1	0.17	High Precision	Polished Serration	Dumostar®	each
72804-12	115	0.1	0.17	High Precision	Polished	Dumostar®	doz
72801-D	115	0.10	0.17	High Precision	Polished	Inox 02	each
72801-DZ	115	0.10	0.17	High Precision	Polished	Inox 02	doz
0102-7-TF-1	115	0.1	0.17	High Precision	PTFE Coated	Inox 02	each
0101-7-PO-1	115	0.08	0.13	High Precision	Polished	Carbon	each
0107-7TI-PO-1	115	0.1	0.17	High Precision	Polished	Titanium	each
72800-D	115	0.03	0.07	Biological	Polished	Dumoxel®	each
72800-DZ	115	0.03	0.07	Biological	Polished	Dumoxel®	doz
0203-7-PS-1	115	0.03	0.07	Biological	Matte	Dumoxel®	each
72803-01	115	0.03	0.07	Biological	Polished	Dumostar®	each
72803-12	115	0.03	0.07	Biological	Polished	Dumostar®	doz
0209-7-PS-1	115	0.03	0.07	Biological	Matte	Dumostar®	each
0208-7-PO	115	0.03	0.07	Biological	Polished	Inox 08	each
0208-7-PS-1	115	0.03	0.07	Biological	Matte	Inox 08	each
2408-7-MF-1	115	0.03	0.07	Biological	Mirror polished	Inox 08	each
3308-7-PO-1	115	0.03	0.07	Biological	Polished	Inox 08	each
3308-7-PS-1	115	0.03	0.07	Biological	Matte	Inox 08	each
0207-7TI-PO-1	115	0.03	0.07	Biological	Polished	Titanium	each
0207-7TI-PS-1	115	0.03	0.07	Biological	Matte	Titanium	each
0508-7-PO	115	0.1	0.17	Biological	Matte	Inox 08	each
0508-7-PS-1	115	0.1	0.17	Biological	Matte	Inox 08	each
3808-7-MF-1	115	0.1	0.17	Biological	Mirror polished	Inox 08	each
72802-D	115	0.1	0.17	Electronic	Epoxy Coated	Inox 02	each
72802-DZ	115	0.1	0.17	Electronic	Epoxy Coated	Inox 02	doz
0304-7-PO	115	0.1	0.17	Electronic	Polished	Antimagnetic	each
0303-7-PO	115	0.1	0.17	Electronic	Polished	Dumoxel®	each
0303-7-PS-1	115	0.1	0.17	Electronic	Matte	Dumoxel®	each

## DUMONT TWEEZERS

Standard, Biological, and Electronic Grade – POSITIVE ACTION

### CURVED & ANGLED STYLES continued

#### III Style 7A

Curved strong tips.



Cat. #	OAL mm	A mm	B mm	Grade	Finish	Alloy	Unit
0103-7A-PO-1	115	0.16	0.24	High Precision	Polished	Dumoxel®	each
0102-7A-PO-1	115	0.16	0.24	High Precision	Polished	Inox 02	each
0101-7A-PO-1	115	0.12	0.2	High Precision	Polished	Carbon	each
5306-7SF-PS-1	115	0.16	0.24	High Precision	Matte	Brass	each
0203-7A-PO	115	0.06	0.1	Biological	Polished	Dumoxel®	each
0203-7A-PS-1	115	0.06	0.1	Biological	Matte	Dumoxel®	each
0508-7A-PO	115	0.06	0.1	Biological	Polished	Inox 08	each
0302-7A-PO-1	115	0.16	0.24	Electronic	Polished	Inox 02	each
0304-7A-PO-1	115	0.16	0.24	Electronic	Polished	Antimagnetic	each
0303-7A-PO-1	115	0.16	0.24	Electronic	Polished	Dumoxel®	each

#### III Style 7B

Curved tips with inside serrations



Cat. #	OAL mm	A mm	B mm	Grade	Finish	Alloy	Unit
0102-7B-PO-1	115	0.1	0.17	High Precision	Polished	Inox 02	each
0103-7B-PO-1	115	0.1	0.17	High Precision	Polished	Dumoxel®	each
0109-7B-PO-1	115	0.1	0.17	High Precision	Polished	Dumostar®	each
0508-7B-PS-1	115	0.1	0.17	Biological	Matte	Inox 08	each
0508-7B-PO	115	0.1	0.17	Biological	Polished Serration	Inox 08	each
0302-7B-PO-1	115	0.1	0.17	Biological	Polished	Inox 02	each
0302-7B-PO-1	115	0.1	0.17	Electronic	Polished	Inox 02	each

#### III Style 7XL

Type 7, extra long, curved thin tips, for large hands.



Cat. #	OAL mm	A mm	B mm	Grade	Finish	Alloy	Unit
0508-7XL-PO	150	0.14	0.24	Biological	Polished Serration	Inox 08	each

#### III Style SS/45

Long narrow shanks, thin tips, bent 45 degrees.



Cat. #	OAL mm	A mm	B mm	Grade	Finish	Alloy	Unit
0508-SS/45-PS-1	133	0.12	0.2	Biological	Matte	Inox 08	each

## You may also need...



### III DUMONT Tweezers Set

Padded with protective foam inside, this tweezers storage box offers you the safe place to store your delicate and valuable tweezers, but keeps them at your reach when you need them.

Set of 7 DUMONT Dumoxel/Biology quality tweezers, includes styles #3 (72690-D), #5 (72700-D), #5/45° (72703-D), #5/15° (72708-D), #5AC (72730-D), #N5 (72854-D) and #7 (72800-D).

This set is ideal for ultramicrotomy work.

Cat. No.	Description	Qty.
72891-01	DUMONT Box & Tweezers Set	each
72891-Bx	DUMONT Tweezers Box Only	each

## Medical Grade

**Medical Grade:** These tweezers are made from stainless steel. They are anti-magnetic.

### STRAIGHT, POSITIVE ACTION

#### III Style 1

Strong tips



Cat. #	OAL mm	A mm	B mm	Grade	Finish	Alloy	Unit
72873-D	120	0.12	0.2	Medical	Mirror Polished	Inox 08	each
72873-DZ	120	0.12	0.2	Medical	Mirror Polished	Inox 08	doz
2408-1-MF-1	120	0.06	0.1	Medical	Mirror Polished	Inox 08	each

#### III Style 2

Strong tips



Cat. #	OAL mm	A mm	B mm	Grade	Finish	Alloy	Unit
72874-D	120	0.14	0.34	Medical	Mirror Polished	Inox 08	each
72874-DZ	120	0.14	0.34	Medical	Mirror Polished	Inox 08	doz
0208-2SP-PO-1	120	0.02	0.4	Medical	Polished	Inox 08	each
3308-2-PO-1	120	0.07	0.17	Medical	Polished	Inox 08	each

#### III Style 3

Thin tips.



Cat. #	OAL mm	A mm	B mm	Grade	Finish	Alloy	Unit
72876-D	120	0.04	0.08	Medical	Mirror Polished	Inox 08	each
72876-DZ	120	0.04	0.08	Medical	Mirror Polished	Inox 08	doz
3308-3-PS-1	120	0.04	0.08	Medical	Matte	Inox 08	each
72690-D	120	0.04	0.08	Medical	Polished	Dumoxel®	each
0208-3-PO	120	0.04	0.08	Medical	Polished	Inox 08	each

#### III Style 3C

Short, thin tips



Cat. #	OAL mm	A mm	B mm	Grade	Finish	Alloy	Unit
0203-3C-PO	110	0.04	0.08	Medical	Polished	Dumoxel®	each
0203-3C-PS-1	110	0.04	0.08	Medical	Matte	Dumoxel®	each
0208-3C-PO	110	0.04	0.08	Medical	Polished	Inox 08	each
0208-3C-PS-1	110	0.04	0.08	Medical	Matte	Inox 08	each
0209-3C-PO	110	0.04	0.08	Medical	Polished	Dumostar®	each
0209-3C-PS-1	110	0.04	0.08	Medical	Matte	Dumostar®	each

#### III Style 4

Very thin tips.



Cat. #	OAL mm	A mm	B mm	Grade	Finish	Alloy	Unit
0207-4TI-PO-1	110	0.02	0.06	Medical	Polished	Titanium	each
0207-4TI-PS-1	110	0.02	0.06	Medical	Matte	Titanium	each
0203-4-PO	110	0.02	0.06	Medical	Polished	Dumoxel®	each
0203-4-PS-1	110	0.02	0.06	Medical	Matte	Dumoxel®	each
0208-4-PO-1	110	0.02	0.06	Medical	Polished	Inox 08	each
0209-4-PO	110	0.02	0.06	Medical	Polished	Dumostar®	each
0209-4-PS-1	110	0.02	0.06	Medical	Matte	Dumostar®	each
0508-4-PS-1	110	0.08	0.13	Medical	Matte	Inox 08	each
0508-4-PO	110	0.08	0.13	Medical	Polished	Inox 08	each
3808-4-MF-1	110	0.02	0.06	Medical	Mirror Polished	Inox 08	each
2408-4-MF-1	110	0.02	0.06	Medical	Mirror Polished	Inox 08	each

#### III Style L4

Extra thin tips, with clamping ring.



Cat. #	OAL mm	A mm	B mm	Grade	Finish	Alloy	Unit
0508-L4-PO	110	0.08	0.13	Medical	Polished	Inox 8	each



## DUMONT TWEEZERS

## Medical Grade (continued)

STRAIGHT, POSITIVE ACTION continued

## III Style 4TM

Thin TM tips with special shape.

Cat. #	OAL mm	A mm	B mm	Grade	Finish	Alloy	Unit
1708-4TM-PO-1	110	0.02	0.06	Medical	Polished	Inox 08	each



## III Style 5

Super thin tips

Cat. #	OAL mm	A mm	B mm	Grade	Finish	Alloy	Unit
72877-D	110	0.01	0.05	Medical	Mirror Polished	Inox 08	each
72877-DZ	110	0.01	0.05	Medical	Mirror Polished	Inox 08	doz



## III Style L5

Super thin tips, with clamping ring.

Cat. #	OAL mm	A mm	B mm	Grade	Finish	Alloy	Unit
0203-L5-PO	110	0.01	0.05	Medical	Polished	Dumoxel®	each
72882-D	110	0.06	0.1	Medical	Polished	Inox 8	each
72882-DZ	110	0.06	0.1	Medical	Polished	Inox 8	doz



## III Style 5A

Oblique tips.

Cat. #	OAL mm	A mm	B mm	Grade	Finish	Alloy	Unit
0203-5A-PO	115	0.01	0.05	Medical	Polished	Dumoxel®	each
0208-5A-PS-1	115	0.02	0.06	Medical	Matte	Inox 08	each
0508-5A-PO	115	0.08	0.13	Medical	Polished	Inox 08	each



## III Style L5A

Oblique tips, with clamping ring.

Cat. #	OAL mm	A mm	B mm	Grade	Finish	Alloy	Unit
72884-D	115	0.08	0.13	Medical	Polished	Inox 8	each
72884-DZ	115	0.08	0.13	Medical	Polished	Inox 8	doz



## III Style 5XL

Type 5, extra long, super thin tips, for large hands

Cat. #	OAL mm	A mm	B mm	Grade	Finish	Alloy	Unit
0508-5XL-PO	150	0.06	0.1	Medical	Polished	Inox 08	each



## III Style 24

Strong serrated tips

Cat. #	OAL mm	A mm	B mm	Grade	Finish	Alloy	Unit
72880-DS	150	0.50	0.50	Medical	Mirror Polished	Inox 08	each
72880-DB	150	0.50	0.50	Medical	Mirror Polished	Inox 08	each



## III Style 180

Long shanks, strong tips.

Cat. #	OAL mm	A mm	B mm	Grade	Finish	Alloy	Unit
72875-D	180	0.25	0.25	Medical	Mirror Polished	Inox 08	each



## III Style PP

Strong tips.

Cat. #	OAL mm	A mm	B mm	Grade	Finish	Alloy	Unit
72878-DS	135	0.14	0.24	Medical	Mirror Polished	Inox 08	each



## Medical Grade (continued)

## CURVED &amp; ANGLED STYLES

## III Style 7

Thin curved tips.

Cat. #	OAL mm	A mm	B mm	Grade	Finish	Alloy	Unit
3808-7-MF-1	115	0.1	0.17	Medical	Mirror polished	Inox 08	each
2408-7-MF-1	115	0.03	0.07	Medical	Mirror polished	Inox 08	each



## III Style L7

Curved, fine points with clamp ring

Cat. #	OAL mm	A mm	B mm	Grade	Finish	Alloy	Unit
72886-D	115	0.1	0.17	Medical	Polished	Inox 08	each
72886-DZ	115	0.1	0.17	Medical	Polished	Inox 08	doz



## III Style 7A

Curved strong tips.

Cat. #	OAL mm	A mm	B mm	Grade	Finish	Alloy	Unit
3808-7A-MF-1	115	0.16	0.24	Medical	Mirror polished	Inox 08	each



## III Style 24/45

Strong tips, bent 45 degrees.

Cat. #	OAL mm	A mm	B mm	Grade	Finish	Alloy	Unit
72800-DB	150	0.5	0.5	Medical	Mirror polished	Inox 08	each



## III Style 5/45

Thin tips, bent 45 degrees,  
for hairsprings

Cat. #	OAL mm	A mm	B mm	Grade	Finish	Alloy	Unit
2408-5/45-MF-1	109	0.01	0.05	Medical	Mirror polished	Inox 08	each



## III Style SS/45

Long narrow shanks,  
thin tips, bent 45 degrees.

Cat. #	OAL mm	A mm	B mm	Grade	Finish	Alloy	Unit
0508-SS/45-PS-1	133	0.12	0.2	Medical	Matte	Inox 08	each



## III Style 5/90

Thin tips, bent 90 degrees.

Cat. #	OAL mm	A mm	B mm	Grade	Finish	Alloy	Unit
2408-5/90-MF-1	106	0.01	0.05	Medical	Mirror polished	Inox 08	each



# DUMONT TWEEZERS

## Standard and Biological Grade – NEGATIVE ACTION

### III Style N0

Flat round tips, bent 30 degrees.

Cat. #	OAL mm	A mm	B mm	Grade	Finish	Alloy	Unit
0202-N0-PO	115	0.04	0.08	Biological	Polished	Inox 02	each



### III Style N0C

Type 0 short, thin tips.

Cat. #	OAL mm	A mm	B mm	Grade	Finish	Alloy	Unit
0102-N0C-PO-1	108	0.1	0.17	High Precision	Polished	Inox 02	each
0202-N0C-PO	108	0.04	0.08	Biological	Polished	Inox 02	each
72868-D	108	0.04	0.08	Biological	Polished	Dumoxel®	each
72868-DZ	108	0.04	0.08	Biological	Polished	Dumoxel®	doz



### III Style N1

Type 1, strong tips.

Cat. #	OAL mm	A mm	B mm	Grade	Finish	Alloy	Unit
0103-N1-PO	118	0.12	0.2	High Precision	Polished	Dumoxel®	each
0102-N1-PO-1	118	0.12	0.2	High Precision	Polished	Inox 02	each



### III Style N2

Type 2, long strong tips.

Cat. #	OAL mm	A mm	B mm	Grade	Finish	Alloy	Unit
0102-N2-PO-1	118	0.14	0.03	High Precision	Polished	Inox 02	each



### III Style N2A

Type 2A, round tips.

Cat. #	OAL mm	A mm	B mm	Grade	Finish	Alloy	Unit
72872-D	118	0.2	1.5	High Precision	Polished	Dumoxel®	each
72872-DZ	118	0.2	1.5	High Precision	Polished	Dumoxel®	doz
0102-N2A-PO-1	118	0.2	1.5	High Precision	Polished	Inox 02	each



### III Style N3

Type 3, thin tips.

Cat. #	OAL mm	A mm	B mm	Grade	Finish	Alloy	Unit
0102-N3-PO-1	118	0.1	0.17	High Precision	Polished	Inox 02	each
72866-D	118	0.04	0.08	Biological	Polished	Dumoxel®	each
72866-DZ	118	0.04	0.08	Biological	Polished	Dumoxel®	doz



### III Style N3C

Type 3 short, thin tips.

Cat. #	OAL mm	A mm	B mm	Grade	Finish	Alloy	Unit
0103-N3C-PO-1	108	0.1	0.17	High Precision	Polished	Dumoxel®	each
72886-D	108	0.04	0.08	Biological	Polished	Dumoxel®	each
72886-DZ	108	0.04	0.08	Biological	Polished	Dumoxel®	doz



### III Style N4

Type 4, very thin tips.

Cat. #	OAL mm	A mm	B mm	Grade	Finish	Alloy	Unit
0103-N4-PO	108	0.08	0.13	High Precision	Polished	Dumoxel®	each
0102-N4-PO-1	108	0.08	0.13	High Precision	Polished	Inox 02	each
0203-N4-PO-1	108	0.02	0.06	Biological	Polished	Dumoxel®	each



### III Style N4AC

Anti-capillary, type 4, very thin tips.

Cat. #	OAL mm	A mm	B mm	Grade	Finish	Alloy	Unit
72870-D	108	0.02	0.07	Biological	Polished	Dumoxel®	each
72870-DZ	108	0.02	0.07	Biological	Polished	Dumoxel®	doz
0203-N4AC-PS-1	108	0.02	0.07	Biological	Matt	Dumoxel®	each
0202-N4AC-PO-1	108	0.02	0.07	Biological	Polished	Inox 02	each
0202-N4AC-PS-1	108	0.02	0.07	Biological	Matt	Inox 02	each



## Standard and Biological Grade – NEGATIVE ACTION

## III Style N5

Type 5, super thin tips.



Cat. #	OAL mm	A mm	B mm	Grade	Finish	Alloy	Unit
0103-N5-PO	108	0.06	0.1	High Precision	Polished	Dumoxel®	each
0102-N5-PO-1	108	0.06	0.1	High Precision	Polished	Inox 02	each
72854-D	108	0.01	0.05	Biological	Polished	Dumoxel®	each
72854-DZ	108	0.01	0.05	Biological	Polished	Dumoxel®	doz
0203-N5-PS-1	108	0.01	0.05	Biological	Matte	Dumoxel®	each
0202-N5-PO	108	0.01	0.05	Biological	Polished	Inox 02	each
0202-N5-PS-1	108	0.01	0.05	Biological	Matte	Inox 02	each
0207-N5TI-PO-1	108	0.01	0.05	Biological	Polished	Titanium	each
0207-N5TI-PS-1	108	0.01	0.05	Biological	Matte	Titanium	each

## III Style N5A

Type 5A, super thin oblique tips.



Cat. #	OAL mm	A mm	B mm	Grade	Finish	Alloy	Unit
0203-N5A-PS-1	113	0.02	0.06	Biological	Matte	Dumoxel®	each
0202-N5A-PS-1	113	0.02	0.06	Biological	Matte	Inox 02	each

## III Style N5AC

Anti-capillary, type 5, super thin tips.



Cat. #	OAL mm	A mm	B mm	Grade	Finish	Alloy	Unit
72856-D	113	0.02	0.07	Biological	Polished	Dumoxel®	each
72856-DZ	113	0.02	0.07	Biological	Polished	Dumoxel®	doz
0203-N5AC-PS-1	113	0.02	0.07	Biological	Matte	Dumoxel®	each
0202-N5AC-PO	113	0.02	0.07	Biological	Polished	Inox 02	each
0202-N5AC-PS-1	113	0.02	0.07	Biological	Matte	Inox 02	each

## III Style N7

Thin curved tips



Cat. #	OAL mm	A mm	B mm	Grade	Finish	Alloy	Unit
72864-D	115	0.03	0.07	Biological	Polished	Dumoxel®	each
72864-DZ	115	0.03	0.07	Biological	Polished	Dumoxel®	doz

## III Style N7AC

Anti-capillary, type 7, super thin tips.



Cat. #	OAL mm	A mm	B mm	Grade	Finish	Alloy	Unit
0203-N7AC-PS-1	115	0.04	0.09	Biological	Matte	Dumoxel®	each
0202-N7AC-PO	115	0.04	0.09	Biological	Polished	Inox 02	each
0202-N7AC-PS-1	115	0.04	0.09	Biological	Matte	Inox 02	each

## III Style NAA

Type AA, strong tips.



Cat. #	OAL mm	A mm	B mm	Grade	Finish	Alloy	Unit
0103-NAA-PO-1	123	0.2	0.4	High Precision	Polished	Dumoxel®	each

## III Style NPP

Type PP, strong tips.



Cat. #	OAL mm	A mm	B mm	Grade	Finish	Alloy	Unit
0103-NPP-PO-1	133	0.14	0.24	High Precision	Polished	Dumoxel®	each
0102-NPP-PO-1	133	0.14	0.24	High Precision	Polished	Inox 02	each

## DUMONT TWEEZERS

## Electronics and Micro-Electronics Tweezers

**Electronic Grade:** These tweezers have a slightly larger tips than the High Precision grade. These tweezers are made from carbon, stainless, and antimagnetic steel.

## STRAIGHT, POSITIVE ACTION

## III Style 0

Geneva pattern, thin tips

Cat. #	OAL mm	A mm	B mm	Grade	Finish	Alloy	Unit
0302-0-PO	115	0.1	0.17	Electronic	Polished	Inox 02	each
0304-0-CO	115	0.1	0.17	Electronic	Epoxy Coated	Antimagnetic	each
0304-0-PO-1	115	0.1	0.17	Electronic	Polished	Antimagnetic	each



## III Style 00

Geneva pattern, strong tips, thick shanks.

Cat. #	OAL mm	A mm	B mm	Grade	Finish	Alloy	Unit
0302-00-CO	115	0.25	0.45	Electronic	Epoxy Coated	Inox 02	each
0304-00-CO	115	0.25	0.45	Electronic	Epoxy Coated	Antimagnetic	each
0304-00-PO-1	115	0.25	0.45	Electronic	Polished	Antimagnetic	each



## III Style 00C

Geneva pattern, strong tips, short shanks.

Cat. #	OAL mm	A mm	B mm	Grade	Finish	Alloy	Unit
0302-00C-PO-1	105	0.25	0.45	Electronic	Polished	Inox 02	each



## III Style 0C100

Geneva pattern

Cat. #	OAL mm	A mm	B mm	Grade	Finish	Alloy	Unit
0302-0C100-CO-1	115	0.1	0.17	Electronic	Epoxy Coated	Inox 02	each
0302-0C100-PO-1	115	0.1	0.17	Electronic	Polished	Inox 02	each
0304-0C100-PO-1	115	0.1	0.17	Electronic	Polished	Antimagnetic	each



## III Style 0C90

Geneva pattern, short

Cat. #	OAL mm	A mm	B mm	Grade	Finish	Alloy	Unit
0302-0C90-CO-1	90	0.1	0.17	Electronic	Epoxy Coated	Inox 02	each
0302-0C90-PO-1	90	0.1	0.17	Electronic	Polished	Inox 02	each
0304-0C90-PO-1	90	0.1	0.17	Electronic	Polished	Antimagnetic	each



## III Style 1

Strong tips.

Cat. #	OAL mm	A mm	B mm	Grade	Finish	Alloy	Unit
0302-1-PO	120	0.12	0.2	Electronic	Polished	Inox 02	each
0304-1-CO	120	0.12	0.2	Electronic	Epoxy Coated	Antimagnetic	each
0304-1-PO-1	120	0.12	0.2	Electronic	Polished	Antimagnetic	each



## III Style 2

Strong tips.

Cat. #	OAL mm	A mm	B mm	Grade	Finish	Alloy	Unit
0303-2-PO	120	0.14	0.34	Electronic	Polished	Dumoxel®	each
0302-2-CO	120	0.14	0.34	Electronic	Epoxy Coated	Inox 02	each
0304-2-CO	120	0.14	0.34	Electronic	Epoxy Coated	Antimagnetic	each
0302-2-PO-1	120	0.14	0.34	Electronic	Polished	Inox 02	each
0304-2-PO-1	120	0.14	0.34	Electronic	Polished	Antimagnetic	each



## III Style 2A

Flat round tips.

Cat. #	OAL mm	A mm	B mm	Grade	Finish	Alloy	Unit
0303-2A-PO	120	0.2	1.5	Electronic	Polished	Dumoxel®	each
0302-2A-CO	120	0.2	1.5	Electronic	Epoxy Coated	Inox 02	each
0302-2A-PO-1	120	0.2	1.5	Electronic	Polished	Inox 02	each
0304-2A-CO	120	0.2	1.5	Electronic	Epoxy Coated	Antimagnetic	each
0304-2A-PO-1	120	0.2	1.5	Electronic	Polished	Antimagnetic	each



## Electronics and Micro-Electronics Tweezers

**STRAIGHT, POSITIVE ACTION** *continued***III Style 2B**

Very strong tips with inside serrations.



Cat. #	OAL mm	A mm	B mm	Grade	Finish	Alloy	Unit
0302-2B-PO-1	160	0.6	3	Electronic	Polished	Inox 02	each
0302-2B3MM-PO-1	160	0.6	3	Electronic	Polished	Inox 02	each
0304-2B-PO-1	160	0.6	3	Electronic	Polished	Antimagnetic	each

**III Style 3**

Thin tips.



Cat. #	OAL mm	A mm	B mm	Grade	Finish	Alloy	Unit
0303-3-PO	120	0.1	0.17	Electronic	Polished	Dumoxel®	each
0302-3-PO	120	0.1	0.17	Electronic	Polished	Inox 02	each
0302-3-CO-1	120	0.1	0.17	Electronic	Epoxy Coated	Inox 02	each
72692-D	120	0.1	0.17	Electronic	Epoxy Coated	Antimagnetic	each
72692-DZ	120	0.1	0.17	Electronic	Epoxy Coated	Antimagnetic	doz
0304-3-PO-1	120	0.1	0.17	Electronic	Polished	Antimagnetic	each
0304-3-TF-1	120	0.1	0.17	Electronic	PTFE Coated	Antimagnetic	each
0306-3-CO-1	120	0.1	0.17	Electronic	Epoxy Coated	Brass	each

**III Style 3C**

Type 3 short, thin tips.



Cat. #	OAL mm	A mm	B mm	Grade	Finish	Alloy	Unit
0303-3C-PO	110	0.1	0.17	Electronic	Polished	Dumoxel®	each
0304-3C-CO-1	110	0.1	0.17	Electronic	Epoxy Coated	Antimagnetic	each
72682-D	110	0.1	0.17	Electronic	Epoxy Coated	Antimagnetic	each
0302-3C-CO-1	110	0.1	0.17	Electronic	Epoxy Coated	Inox 02	each
0302-3C-PO-1	110	0.1	0.17	Electronic	Polished	Inox 02	each
0304-3C-PO-1	110	0.1	0.17	Electronic	Polished	Antimagnetic	each

**III Style 4**

Strong thin tips.



Cat. #	OAL mm	A mm	B mm	Grade	Finish	Alloy	Unit
0303-4-PO	110	0.08	0.13	Electronic	Polished	Dumoxel®	each
0302-4-PO	110	0.08	0.13	Electronic	Polished	Inox 02	each
0302-4-CO-1	110	0.08	0.13	Electronic	Epoxy Coated	Inox 02	each
0304-4-CO	110	0.08	0.13	Electronic	Epoxy Coated	Antimagnetic	each
0304-4-PO-1	110	0.08	0.13	Electronic	Polished	Antimagnetic	each

**III Style 5**

Super thin tips.



Cat. #	OAL mm	A mm	B mm	Grade	Finish	Alloy	Unit
0302-5-CO	110	0.06	0.1	Electronic	Epoxy Coated	Inox 2	each
0302-5-PO	110	0.06	0.1	Electronic	Polished	Inox 2	each
72702-D	110	0.06	0.1	Electronic	Epoxy Coated	Antimagnetic	each
72702-DZ	110	0.06	0.1	Electronic	Epoxy Coated	Antimagnetic	doz
72702-DTIP	110	0.06	0.1	Electronic	PTFE Coated, Tip Coated	Antimagnetic	each
72702-DTIP-DZ	110	0.06	0.1	Electronic	PTFE Coated, Tip Coated	Antimagnetic	doz
0303-5-PO	110	0.06	0.1	Electronic	Polished	Dumoxel®	each
0303-5-TF	110	0.06	0.1	Electronic	PTFE Coated	Dumoxel®	each
0304-5-TF	110	0.06	0.1	Electronic	PTFE Coated	Antimagnetic	each
0302-5-PS-1	110	0.06	0.1	Electronic	Matte	Inox 02	each
0304-5-PO-1	110	0.06	0.1	Electronic	Polished	Antimagnetic	each
0304-5-PS-1	110	0.06	0.1	Electronic	Matte	Antimagnetic	each
0303-5-PS-1	110	0.06	0.1	Electronic	Matte	Dumoxel®	each

**III Style 5A**

Oblique tips



Cat. #	OAL mm	A mm	B mm	Grade	Finish	Alloy	Unit
0302-5A-PO-1	115	0.08	0.13	Electronic	Polished	Inox 02	each

## DUMONT TWEEZERS

## Electronics and Micro-Electronics Tweezers

STRAIGHT, POSITIVE ACTION continued

## III Style 11

Strong tips. Ideal for manipulating delicate pieces.



Cat. #	OAL mm	A mm	B mm	Grade	Finish	Alloy	Unit
0305-11NI-CO	120	0.14	0.24	Electronic	Epoxy Coated	Nickel	each
0305-11NI-PO	120	0.14	0.24	Electronic	Polished	Nickel	each

## III Style 12

Strong tips.



Cat. #	OAL mm	A mm	B mm	Grade	Finish	Alloy	Unit
0305-12NI-CO	120	0.1	0.17	Electronic	Epoxy Coated	Nickel	each
0305-12NI-PO	120	0.1	0.17	Electronic	Polished	Nickel	each

## III Style 24

Strong tips with inside serrations.



Cat. #	OAL mm	A mm	B mm	Grade	Finish	Alloy	Unit
0302-24-PO-1	150	0.5	0.5	Electronic	Polished	Inox 02	each
0303-24-PO	150	0.5	0.5	Electronic	Polished	Dumoxel®	each
0307-24TI-PO-1	150	0.5	0.5	Electronic	Polished	Titanium	each

## III Style 180

Long shanks, strong tips.



Cat. #	OAL mm	A mm	B mm	Grade	Finish	Alloy	Unit
0302-180-PO-1	180	0.5	0.5	Electronic	Polished	Inox 02	each
0304-180-PO	180	0.5	0.5	Electronic	Polished	Antimagnetic	each

## III Style A

Strong tips



Cat. #	OAL mm	A mm	B mm	Grade	Finish	Alloy	Unit
0302-A-PO-1	115	0.35	0.6	Electronic	Polished	Inox 02	each

## III Style AA

Strong tips



Cat. #	OAL mm	A mm	B mm	Grade	Finish	Alloy	Unit
0303-AA-PO-1	125	0.2	0.4	Electronic	Polished	Dumoxel®	each
0302-AA-CO-1	125	0.2	0.4	Electronic	Epoxy Coated	Inox 02	each
0302-AA-PO-1	125	0.2	0.4	Electronic	Polished	Inox 02	each
0304-AA-CO-1	125	0.2	0.4	Electronic	Epoxy Coated	Antimagnetic	each
0304-AA-PO-1	125	0.2	0.4	Electronic	Polished	Antimagnetic	each

## III Style F

Wide square tips.



Cat. #	OAL mm	A mm	B mm	Grade	Finish	Alloy	Unit
0304-F-PO-1	120	0.2	2	Electronic	Polished	Antimagnetic	each

## III Style GG

Strong and very precise



Cat. #	OAL mm	A mm	B mm	Grade	Finish	Alloy	Unit
72816-D	130	0.12	0.2	Electronic	Polished	Antimagnetic	each
72816-DZ	130	0.12	0.2	Electronic	Polished	Antimagnetic	doz

## Electronics and Micro-Electronics Tweezers

**STRAIGHT, POSITIVE ACTION** continued**III Style H**

Triangle tips, short shanks.



Cat. #	OAL mm	A mm	B mm	Grade	Finish	Alloy	Unit
0302-H-PO-1	90	0.1	0.17	Electronic	Polished	Inox 02	each
0304-H-PO-1	90	0.1	0.17	Electronic	Polished	Antimagnetic	each

**III Style MM**

Assembling tweezers.



Cat. #	OAL mm	A mm	B mm	Grade	Finish	Alloy	Unit
0302-MM-CO-1	127	0.22	0.26	Electronic	Epoxy Coated	Inox 02	each
0302-MM-PO-1	127	0.22	0.26	Electronic	Polished	Inox 02	each
0304-MM-PO-1	127	0.22	0.26	Electronic	Polished	Antimagnetic	each

**III Style NN**

Assembling tweezers.



Cat. #	OAL mm	A mm	B mm	Grade	Finish	Alloy	Unit
0302-NN-PO-1	115	0.2	0.4	Electronic	Polished	Inox 02	each
0304-NN-CO-1	115	0.2	0.4	Electronic	Epoxy Coated	Antimagnetic	each

**III Style SS135**

Long narrow shanks, thin tips.



Cat. #	OAL mm	A mm	B mm	Grade	Finish	Alloy	Unit
0304-SS135-CO	135	0.12	0.2	Electronic	Epoxy Coated	Antimagnetic	each
0304-SS135-PO	135	0.12	0.2	Electronic	Polished	Antimagnetic	each

**III Style SS140**

Long narrow shanks, thin tips.



Cat. #	OAL mm	A mm	B mm	Grade	Finish	Alloy	Unit
0304-SS140-CO-1	140	0.12	0.2	Electronic	Epoxy Coated	Antimagnetic	each
0304-SS140-PO-1	140	0.12	0.2	Electronic	Polished	Antimagnetic	each

**DIAMOND TWEEZERS**

Dumont Stainless Steel tweezers coated with an extremely fine diamond dust on the inside tips. They are essential in applications where a tight grip is necessary. They are also available with an improved locking system. They are 5½"(150mm) long. They may not be suitable for use with EM grids.

**III Fine Points Diamond Tweezers**

Cat. #	OAL mm	A mm	B mm	Grade	Finish	Alloy	Unit
78100	150	0.25	0.25	Electronic	Diamond	Inox 02	each

**MINI TWEEZERS****III Style 5**

Type 5 mini, super thin tips.



Cat. #	OAL mm	A mm	B mm	Grade	Finish	Alloy	Unit
0302-M5S-PS	83	0.06	0.1	Electronic	Matte	Inox 02	each



# DUMONT TWEEZERS

## Electronics and Micro-Electronics Tweezers

### III Dumont Tweezers Set in Wooden Case

*Dumont tweezers in a fine wood display case.*

#### Dumont Tweezers Set 1:

This set includes all of the fine tip Dumont tweezers made from Dumoxel steel (biological grade): specifically used in the field of microscopy for all delicate and precise work. The kit includes one each of a Dumont style 3C (72680-D), style 3 (72690-D), style 5 (72700-D), style 5/15 (72708-D) and style 7 (72800-D).

**72890-01** Dumont Fine Tips Tweezers Set 1 5/set

#### Dumont Tweezers Set 2:

This set includes one each of: style 3C Epoxy Coated (72682-D), Style 5A (72720-D), style 5/45 (72703-D), style 5AC (72730-D) and style N5AC (72856-D).

**72890-02** Dumont Fine Tips Tweezers Set 2 5/set

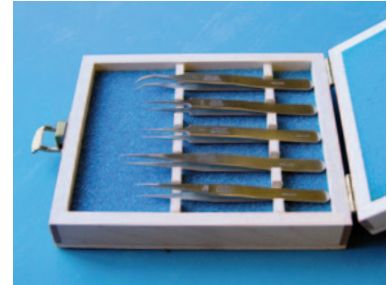

### III DUMONT Tweezers Set

Made from lightweight plastic and padded with protective foam inside, this tweezers storage box offers you the safe place to store your delicate and valuable tweezers, but keeps them at your reach when you need them.

Set of 7 DUMONT Dumoxel/Biology quality tweezers, includes styles #3 (72690-D), #5 (72700-D), #5/45° (72703-D), #5/15° (72708-D), #5AC (72730-D), #N5 (72854-D) and #7 (72800-D). This set is ideal for ultramicrotomy work.

**72891-01** DUMONT Box & Tweezers Set each

**72891-Bx** DUMONT Tweezers Box Only each

### III Wooden Tweezers Holder Case

Made from solid wood, with brass double hinges and an elegant latch. Comes with a foam padded top and bottom to protect stored tweezers. The inside measures 5 3/4" x 4 1/8" (145 x 124 mm) and it holds 5 tweezers with a maximum length of 140mm.

**72898-01** Wooden Tweezers Holder Case each

### III Tweezer Boxes

#### Box for 3 Tweezers

Cat #	Finish	Material	Unit
<b>BOX.W-003</b>	White varnish with logo	Wood	each

#### Box for 5 Tweezers

Cat #	Finish	Material	Unit
<b>BOX.W-005</b>	White varnish with logo	Wood	each

#### Box for 7 Tweezers

Cat #	Finish	Material	Unit
<b>BOX.W-007</b>	White varnish with logo	Wood	each



BOX.W-003



BOX.W-007

Tweezers sold separately



BOX.W-005

## Electronics and Micro-Electronics Tweezers

## CURVED &amp; ANGLED, POSITIVE ACTION

## III Style 2A/30

Flat round tips, bent 30 degrees.



Cat. #	OAL mm	A mm	B mm	Grade	Finish	Alloy	Unit
0303-2A/30-PO-1	118	0.2	1.5	Electronic	Polished	Dumoxel®	each

## III Style 5/15

Thin tips, bent 15 degrees.



Cat. #	OAL mm	A mm	B mm	Grade	Finish	Alloy	Unit
0304-5/15-PO	105	0.06	0.1	Electronic	Polished	Antimagnetic	each
0302-5/15-PO-1	105	0.06	0.1	Electronic	Polished	Inox 02	each

## III Style 5/45

Thin tips, bent 45 degrees.



Cat. #	OAL mm	A mm	B mm	Grade	Finish	Alloy	Unit
0302-5/45-PO-1	109	0.06	0.1	Electronic	Polished	Inox 02	each
0304-5/45-PO	109	0.06	0.1	Electronic	Polished	Antimagnetic	each

## III Style 5/90

Thin tips, bent 90 degrees.



Cat. #	OAL mm	A mm	B mm	Grade	Finish	Alloy	Unit
0302-5/90-PO	106	0.06	0.1	Electronic	Polished	Inox 02	each

## III Style 6

Thin hooked tips.



Cat. #	OAL mm	A mm	B mm	Grade	Finish	Alloy	Unit
0304-6-CO-1	115	0.1	0.17	Electronic	Epoxy Coated	Antimagnetic	each
0304-6-PO-1	115	0.1	0.17	Electronic	Polished	Antimagnetic	each

## III Style 7

Thin curved tips.



Cat. #	OAL mm	A mm	B mm	Grade	Finish	Alloy	Unit
72802-D	115	0.1	0.17	Electronic	Epoxy Coated	Inox 02	each
72802-DZ	115	0.1	0.17	Electronic	Epoxy Coated	Inox 02	doz
0304-7-PO	115	0.1	0.17	Electronic	Polished	Antimagnetic	each
0303-7-PO	115	0.1	0.17	Electronic	Polished	Dumoxel®	each
0303-7-PS-1	115	0.1	0.17	Electronic	Matte	Dumoxel®	each

## III Style 7A

Curved strong tips.



Cat. #	OAL mm	A mm	B mm	Grade	Finish	Alloy	Unit
0302-7A-PO-1	115	0.16	0.24	Electronic	Polished	Inox 02	each
0304-7A-PO-1	115	0.16	0.24	Electronic	Polished	Antimagnetic	each
0303-7A-PO-1	115	0.16	0.24	Electronic	Polished	Dumoxel®	each

## III Style 7B

Curved tips with inside serrations



Cat. #	OAL mm	A mm	B mm	Grade	Finish	Alloy	Unit
0302-7B-PO-1	115	0.1	0.17	Electronic	Polished	Inox 02	each

## III Style 24/45

Strong tips, bent 45 degrees.



Cat. #	OAL mm	A mm	B mm	Grade	Finish	Alloy	Unit
0302-24/45-PO-1	145	0.5	0.5	Electronic	Polished	Inox 02	each

# DUMONT TWEEZERS

## Electronics and Micro-Electronics Tweezers

### NEGATIVE ACTION

#### III Style N0

Flat round tips, bent 30 degrees.



Cat. #	OAL mm	A mm	B mm	Grade	Finish	Alloy	Unit
0302-N0-PO-1	115	0.1	0.17	Electronic	Polished	Inox 02	each

#### III Style N0C

Type 0 short, thin tips.



Cat. #	OAL mm	A mm	B mm	Grade	Finish	Alloy	Unit
0302-N0C-PO-1	108	0.1	0.17	Electronic	Polished	Antimagnetic	each
0304-N0C-PO	108	0.1	0.17	Electronic	Polished	Antimagnetic	each

#### III Style N1

Type 1, strong tips.



Cat. #	OAL mm	A mm	B mm	Grade	Finish	Alloy	Unit
0302-N1-PO-1	118	0.12	0.2	Electronic	Polished	Inox 02	each
0303-N1-PO-1	118	0.12	0.2	Electronic	Polished	Dumoxel®	each

#### III Style N2

Type 2, long strong tips.



Cat. #	OAL mm	A mm	B mm	Grade	Finish	Alloy	Unit
0304-N2-PO	118	0.14	0.34	Electronic	Polished	Antimagnetic	each

#### III Style N2A

Type 2A, round tips.



Cat. #	OAL mm	A mm	B mm	Grade	Finish	Alloy	Unit
0302-N2A-PO-1	118	0.2	1.5	Electronic	Polished	Inox 02	each
0304-N2A-PO	118	0.2	1.5	Electronic	Polished	Antimagnetic	each

#### III Style N3

Type 3, thin tips.



Cat. #	OAL mm	A mm	B mm	Grade	Finish	Alloy	Unit
0304-N3-PO	118	0.1	0.17	Electronic	Polished	Antimagnetic	each

## You may also need... Tweezer Accessories

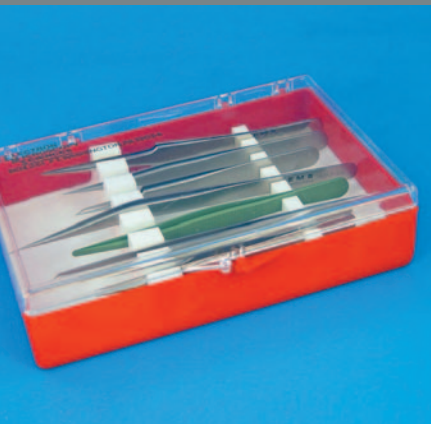

#### III EMS Tweezer Protection Box

Made from soft silicone; grooved properly to tightly hold all types of tweezers in place. The tip of the tweezer is always well protected from any damage. The silicone pad is held in a plastic box with a hinged lid that keeps the tweezers free from dust. Holds 7 tweezers.

**Overall measurements:** 6 1/8"(L)x4 1/4"(W)x1 3/8"(H);  
**Inside measurements:** 6"(L)x4"(W)x1 1/4"(H)

Cat. No.	Description	Qty.
72902	Tweezer Protection Box	each

#### III O-Rings for Tweezers

This Neoprene O-Ring is used as a simple clamping device for tweezers.

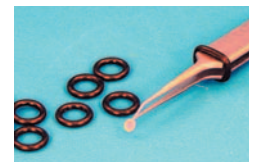

Cat. No.	Description	Qty.
72903-12	Tweezers O-Rings	12/pk.

## Electronics and Micro-Electronics Tweezers

**NEGATIVE ACTION** *continued***III Style N3C**

Type 3 short, thin tips.



Cat. #	OAL mm	A mm	B mm	Grade	Finish	Alloy	Unit
0302-N3C-PO-1	108	0.1	0.17	Electronic	Polished	Inox 02	each

**III Style N4**

Type 4, very thin tips.



Cat. #	OAL mm	A mm	B mm	Grade	Finish	Alloy	Unit
0304-N4-PO-1	108	0.08	0.13	Electronic	Polished	Inox 02	each

**III Style N5**

Type 5, super thin tips.



Cat. #	OAL mm	A mm	B mm	Grade	Finish	Alloy	Unit
0304-N5-PO	108	0.06	0.1	Electronic	Polished	Antimagnetic	each
0302-N5-PO-1	108	0.06	0.1	Electronic	Polished	Inox 02	each

**III Style N5A**

Type 5A, super thin oblique tips.



Cat. #	OAL mm	A mm	B mm	Grade	Finish	Alloy	Unit
0302-N5A-PO-1	113	0.08	0.13	Electronic	Polished	Inox 02	each

**III Style NAA**

Type AA, strong tips.



Cat. #	OAL mm	A mm	B mm	Grade	Finish	Alloy	Unit
0304-NAA-CO-1	123	0.2	0.4	Electronic	Epoxy Coated	Antimagnetic	each

**III Style NPP**

Type PP, strong tips.



Cat. #	OAL mm	A mm	B mm	Grade	Finish	Alloy	Unit
0304-NPP-PO-1	133	0.14	0.24	Electronic	Polished	Antimagnetic	each

**III The Tweezer Repair Kit**

This repair kit allows you to straighten, sharpen, and repair your tweezers that have been damaged or have become dull. Instructions are included with the kit

The kit includes:

- 1 Sharpening stone
- Chain nose pliers
- Instrument Oil, 50 ml
- Ten O-rings

Cat. No.	Description	Qty.
72892-10	The Tweezer Repair Kit	kit



# DUMONT TWEEZERS

## Ergonomic ESD Tweezers

### III Style 00

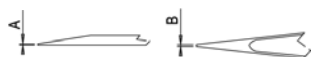

Cat. #	OAL mm	A mm	B mm	Finish	Color	Alloy	Unit
0304-00SAESD-ET1	115	0.25	0.45	Polished	Red	Antimagnetic	each
0304-00SAESD-ET2	115	0.25	0.45	Polished	Black	Antimagnetic	each

### III Style 2

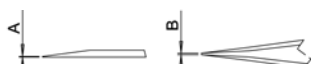

Cat. #	OAL mm	A mm	B mm	Finish	Color	Alloy	Unit
0304-2SAESD-ET1	120	0.14	0.34	Polished	Red	Antimagnetic	each
0304-2SAESD-ET2	120	0.14	0.34	Polished	Black	Antimagnetic	each

### III Style 2A



Cat. #	OAL mm	A mm	B mm	Finish	Color	Alloy	Unit
0304-2ASAESD-ET1	120	0.20	1.50	Polished	Red	Antimagnetic	each
0304-2ASAESD-ET2	120	0.20	1.50	Polished	Black	Antimagnetic	each

### III Style 3

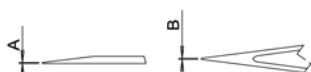

Cat. #	OAL mm	A mm	B mm	Finish	Color	Alloy	Unit
0304-3SAESD-ET1	120	0.10	0.17	Polished	Red	Antimagnetic	each
0304-3SAESD-ET2	120	0.10	0.17	Polished	Black	Antimagnetic	each

### III Style 3C



Cat. #	OAL mm	A mm	B mm	Finish	Color	Alloy	Unit
0304-3CSAESD-ET1	110	0.10	0.17	Polished	Red	Antimagnetic	each
0304-3CSAESD-ET2	110	0.10	0.17	Polished	Black	Antimagnetic	each

### III Style 5



Cat. #	OAL mm	A mm	B mm	Finish	Color	Alloy	Unit
0304-5SAESD-ET1	110	0.06	0.10	Polished	Red	Antimagnetic	each
0304-5SAESD-ET2	110	0.06	0.10	Polished	Black	Antimagnetic	each

### III Style 5/45

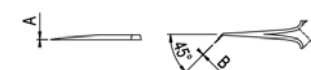

Cat. #	OAL mm	A mm	B mm	Finish	Color	Alloy	Unit
0304-545SAESD-ET1	109	0.06	0.10	Polished	Red	Antimagnetic	each
0304-545SAESD-ET2	109	0.06	0.10	Polished	Black	Antimagnetic	each

### III Style 5A

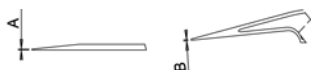

Cat. #	OAL mm	A mm	B mm	Finish	Color	Alloy	Unit
0304-5ASAESD-ET1	115	0.08	0.13	Polished	Red	Antimagnetic	each
0304-5ASAESD-ET2	115	0.08	0.13	Polished	Black	Antimagnetic	each

### III Style 7



Cat. #	OAL mm	A mm	B mm	Finish	Color	Alloy	Unit
0304-7SAESD-ET1	115	0.10	0.17	Polished	Red	Antimagnetic	each
0304-7SAESD-ET2	115	0.10	0.17	Polished	Black	Antimagnetic	each

### III Style F



Cat. #	OAL mm	A mm	B mm	Finish	Color	Alloy	Unit
0304-FSAESD-ET1	120	0.20	2.00	Polished	Red	Antimagnetic	each
0304-FSAESD-ET2	120	0.20	2.00	Polished	Black	Antimagnetic	each

## ESD Tweezers

### Style 00 SA ESD



Geneva pattern, strong tips, thick body.



Cat. #	OAL mm	A mm	B mm	Finish	Alloy	Unit
0304-00SAESD-CO	115	0.25	0.45	Epoxy Coated	Antimagnetic	each

### Style 2 SA ESD

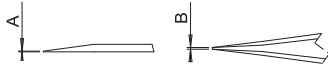

Strong tips.



Cat. #	OAL mm	A mm	B mm	Finish	Alloy	Unit
0304-2SAESD-CO	120	0.14	0.34	Epoxy Coated	Antimagnetic	each

### Style 2A SA ESD

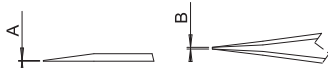

Flat rounded tips.



Cat. #	OAL mm	A mm	B mm	Finish	Alloy	Unit
0304-2ASAESD-CO	120	0.2	1.5	Epoxy Coated	Antimagnetic	each

### Style 3A SA ESD

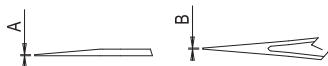

Thin tips.



Cat. #	OAL mm	A mm	B mm	Finish	Alloy	Unit
0304-3SAESD-CO	120	0.1	0.17	Epoxy Coated	Antimagnetic	each

### Style 5/45 SA ESD

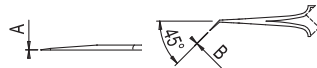

Thin tips, bent 45 degrees.



Cat. #	OAL mm	A mm	B mm	Finish	Alloy	Unit
0304-5/45SAESD-CO	109	0.06	0.1	Epoxy Coated	Antimagnetic	each

### Style SS135 SA ESD

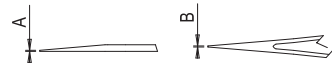

Long narrow shanks, thin tips.



Cat. #	OAL mm	A mm	B mm	Finish	Alloy	Unit
0304-SSSAESD-CO	135	0.12	0.2	Epoxy Coated	Antimagnetic	each

### Style AA SA ESD

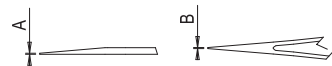

Strong tips.



Cat. #	OAL mm	A mm	B mm	Finish	Alloy	Unit
0304-AASAESD-CO	125	0.2	0.4	Epoxy Coated	Antimagnetic	each

# DUMONT TWEEZERS

## Component Handling Tweezers

### III Style 2E1/8

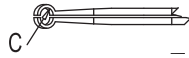

Cat. #	OAL mm	C mm
0102-2E1/8-PO-1	118	3.2
0102-2E1/8-PS-1	118	3.2
0103-2E1/8-PO-1	118	3.2
0103-2E1/8-PS-1	118	3.2



Finish	Alloy	Unit
Polished	Inox 02	each
Matte	Inox 02	each
Polished	Dumoxel®	each
Matte	Dumoxel®	each

### III Style 2E1/8



Cat. #	OAL mm	C mm
0302-2E1/8-PO	118	3.2
0304-2E1/8-PO	118	3.2



Finish	Alloy	Unit
Polished	Inox 02	each
Polished	Antimagnetic	each

### III Style 2E1/4

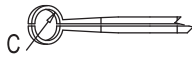

Cat. #	OAL mm	C mm
0102-2E1/4-PS-1	118	6.4
0103-2E1/4-PO-1	118	6.4
0103-2E1/4-PS-1	118	6.4



Finish	Alloy	Unit
Matte	Inox 02	each
Polished	Dumoxel®	each
Matte	Dumoxel®	each

### III Style 2E1/4



Cat. #	OAL mm	C mm
0302-2E1/4-PO-1	118	6.4
0304-2E1/4-PO-1	118	6.4



Finish	Alloy	Unit
Polished	Inox 02	each
Polished	Antimagnetic	each

### III Style 2E1/2

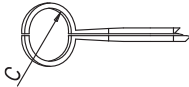

Cat. #	OAL mm	C mm
0102-2E1/2-PO-1	118	12.7
0103-2E1/2-PO-1	118	12.7



Finish	Alloy	Unit
Polished	Inox 02	each
Polished	Dumoxel®	each

### III Style 2E1/2

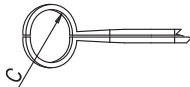

Cat. #	OAL mm	C mm
0302-2E1/2-PO-1	118	12.7
0304-2E1/2-PO-1	118	12.7



Finish	Alloy	Unit
Polished	Inox 02	each
Polished	Antimagnetic	each

## Wafer Handling Tweezers

### III Style 34A



Cat. #	OAL mm	A mm	B mm
0403-34A-PS	120	0.15	7



Finish	Alloy	Unit
Matte	Dumoxel®	each

### III Style 37S



Cat. #	OAL mm	A mm	B mm
0403-37S-PS	120	0.2	7



Finish	Alloy	Unit
Matte	Dumoxel®	each

## Instruments for Chemistry, Radiochemistry and Radiation Metrology

*Dumont Swiss-Made Professional tools that exceed all expectations!*

We are pleased to be able to offer these new exceptional products! These exclusive new products meet the highest quality standards. They are adapted for Chemistry, Radiochemistry and Radiation Metrology.

## Replaceable Tip Tweezers

## III Style DIRPY1

Long sleeve, Delrin replaceable tips

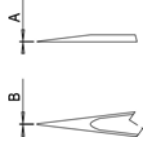

Cat. #	OAL mm	A mm	B mm	Weight	Description	Alloy	Unit
76723-13	210	1	1	210	Matte	Inox 08	each
76723-15	210	1	1	45	Matte	Delrin	each

## III Style DIRPY2

Long sleeve, Delrin replaceable tips

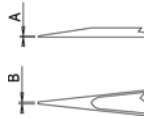

Cat. #	OAL mm	A mm	B mm	Weight	Description	Alloy	Unit
76723-14	210	2	2	210	Matte	Inox 08	each
76723-16	210	2	2	45	Matte	Delrin	each

## Flask Tongs

These tongs have long arms for optimal user protection when gripping, and feature a constant spring, thanks to the non-welded, one-piece body. They have a superior grip and hold of the object and their coated tips reduce antistatic charge.

## III Style ER13TSC

Long handle, covered tips for antistatic protection

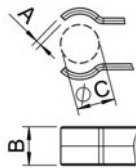

Cat. #	A mm	B mm	C mm	L mm	Description	Alloy	Unit
76723-10	1.8	12	12	250	Matte	Inox 08	each

## III Style ER23TSC

Long handle, covered tips for antistatic protection

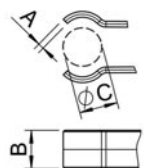

Cat. #	A mm	B mm	C mm	L mm	Description	Alloy	Unit
76723-11	1.8	12	22	250	Matte	Inox 08	each

## III Style ER23TSC

Long handle, covered tips for antistatic protection

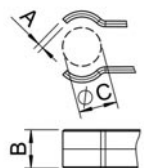

Cat. #	A mm	B mm	C mm	L mm	Description	Alloy	Unit
76723-12	1.8	12	32	250	Matte	Inox 08	each



# DUMONT TWEEZERS

## Tweezers and Replaceable Tips

These tweezers are antimagnetic.

### WA Essence

#### III Style B159

WA1 Handle with 159-BUIS Tips

Torque: cN.m 9 +/-1



Cat. #	OAL mm	A mm	B mm	Weight	Description	Alloy	Unit
10004-B159-SM	130	0.50	0.50	20g	Handle & Tips	Antimagnetic	each
TIP-159-BUI	130	0.50	0.50	1g	Replaceable Tips	Boxwood (Buxus)	each

#### III Style BF

WA1 Handle with F-BUIS Tips

Torque: cN.m 9 +/-1

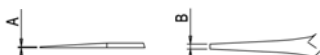

Cat. #	OAL mm	A mm	B mm	Weight	Description	Alloy	Unit
10004-BF-SM	130	0.20	2.00	19g	Handle & Tips	Antimagnetic	each
TIP-F-BUI		0.20	2.00	1g	Replaceable Tips	Boxwood (Buxus)	each

#### III Style BFSP

WA1 Handle with FSP-BUIS Tips

Torque: cN.m 9 +/-1

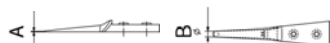

Cat. #	OAL mm	A mm	B mm	Weight	Description	Alloy	Unit
10004-BFSP-SM	130	0.20	2.00	19g	Handle & Tips	Antimagnetic	each
TIP-FSP-BUI		0.20	2.00	1g	Replaceable Tips	Boxwood (Buxus)	each

#### III Style B2A

WA1 Handle with 2A-BUIS Tips

Torque: cN.m 9 +/-1



Cat. #	OAL mm	A mm	B mm	Weight	Description	Alloy	Unit
10004-B2A-SM	130	0.20	1.50	19g	Handle & Tips	Antimagnetic	each
TIP-2A-BUI		0.20	1.50	1g	Replaceable Tips	Boxwood (Buxus)	each

#### III Style B45

WA1 Handle with 45-BUIS Tips

Torque: cN.m 9 +/-1

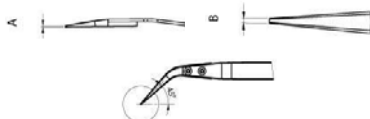

Cat. #	OAL mm	A mm	B mm	Weight	Description	Alloy	Unit
10004-B45-SM	130	0.50	0.50	19g	Handle & Tips	Antimagnetic	each
TIP-B45-BUI		0.50	0.50	1g	Replaceable Tips	Boxwood (Buxus)	each

#### III Style B7

WA1 Handle with 7-BUIS Tips

Torque: cN.m 9 +/-1

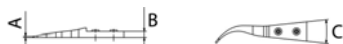

Cat. #	OAL mm	A mm	B mm	Weight	Description	Alloy	Unit
10004-B7-SM	130	0.50	12.00	19g	Handle & Tips	Antimagnetic	each
TIP-7-BUI		0.50	12.00	1g	Replaceable Tips	Boxwood (Buxus)	each

## Tweezers and Replaceable Tips

## WA Delrin

## III Style D4

WA1 Handle  
with 4-DEL Tips



Cat. #	OAL mm	A mm	B mm	Weight	Description	Alloy	Unit
10004-D4-SM	130	0.60	0.30	19g	Handle & Tips	Antimagnetic	each
TIP-4-DEL		0.60	0.30	1g	Replaceable Tips	White Delrin	each

## III Style D15

WA1 Handle  
with 15-DEL Tips



Cat. #	OAL mm	A mm	B mm	Weight	Description	Alloy	Unit
10004-D15-SM	130	0.30	0.30	19g	Handle & Tips	Antimagnetic	each
TIP-15-DEL		0.30	0.30	1g	Replaceable Tips	White Delrin	each

## III Style D17

WA1 Handle  
with 17-DEL Tips



Cat. #	OAL mm	A mm	B mm	Weight	Description	Alloy	Unit
10004-D17-SM	130	1.50	0.35	19g	Handle & Tips	Antimagnetic	each
TIP-17-DEL		1.50	0.35	1g	Replaceable Tips	White Delrin	each

## III Style D17B

WA1 Handle  
with 17B-DEL Tips



Cat. #	OAL mm	A mm	B mm	Weight	Description	Alloy	Unit
10004-D17B-SM	130	1.50	0.25	19g	Handle & Tips	Antimagnetic	each
TIP-17B-DEL		1.50	0.25	1g	Replaceable Tips	White Delrin	each

## III Style D20

WA1 Handle  
with 20-DEL Tips



Cat. #	OAL mm	A mm	B mm	C mm	Weight	Description	Alloy	Unit
10004-D20-SM	130	2.50	0.50	1.50	20g	Handle & Tips	Antimagnetic	each
TIP-20-DEL		2.50	0.50	1.50	1g	Replaceable Tips	White Delrin	each

## III Style D22

WA1 Handle  
with 22-DEL Tips

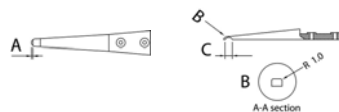

Cat. #	OAL mm	A mm	B mm	C mm	Weight	Description	Alloy	Unit
10004-D22-SM	125	0.50	1.00	2.50	20g	Handle & Tips	Antimagnetic	each
TIP-22-DEL		0.50	1.00	2.50	1g	Replaceable Tips	White Delrin	each

# DUMONT TWEEZERS

## Tweezers and Replaceable Tips, continued

### WA ESD

#### III Style E4

WA1 Handle  
with 4-ESD Tips



Cat. #	OAL mm	A mm	B mm	Weight	Description	Alloy	Unit
10004-E4-SM	130	0.60	0.30	19g	Handle & Tips	Antimagnetic	each
TIP-4-ESD		0.60	0.30	1g	Replaceable Tips	Black ESD	each

#### III Style E10A

WA1 Handle  
with 10A-ESD Tips



Cat. #	OAL mm	A mm	B mm	Weight	Description	Alloy	Unit
10004-E10A-SM	125	0.60	0.50	19g	Handle & Tips	Antimagnetic	each
TIP-10A-ESD		0.60	0.50	1g	Replaceable Tips	Black ESD	each

#### III Style E15

WA1 Handle  
with 15-ESD Tips



Cat. #	OAL mm	A mm	B mm	Weight	Description	Alloy	Unit
10004-E15-SM	130	0.30	0.30	19g	Handle & Tips	Antimagnetic	each
TIP-15-ESD		0.30	0.30	1g	Replaceable Tips	Black ESD	each

#### III Style E16

WA1 Handle  
with 16-ESD Tips



Cat. #	OAL mm	A mm	B mm	Weight	Description	Alloy	Unit
10004-E16-SM	130	0.25	0.15	19g	Handle & Tips	Antimagnetic	each
TIP-16-ESD		0.25	0.15	1g	Replaceable Tips	Black ESD	each

#### III Style E17

WA1 Handle  
with 17-ESD Tips



Cat. #	OAL mm	A mm	B mm	Weight	Description	Alloy	Unit
10004-E17-SM	130	1.50	0.35	19g	Handle & Tips	Antimagnetic	each
TIP-17-ESD		1.50	0.35	1g	Replaceable Tips	Black ESD	each

#### III Style E17B

WA1 Handle  
with 17B-ESD Tips



Cat. #	OAL mm	A mm	B mm	Weight	Description	Alloy	Unit
10004-E17B-SM	130	1.50	0.25	19g	Handle & Tips	Antimagnetic	each
TIP-17B-ESD		1.50	0.25	1g	Replaceable Tips	Black ESD	each

#### III Style E20

WA1 Handle  
with 20-ESD Tips



Cat. #	OAL mm	A mm	B mm	C mm	Weight	Description	Alloy	Unit
10004-E20-SM	125	2.50	0.50	1.50	20g	Handle & Tips	Antimagnetic	each
TIP-20-ESD		2.50	0.50	1.50	1g	Replaceable Tips	Black ESD	each

#### III Style E22

WA1 Handle  
with 22-ESD Tips

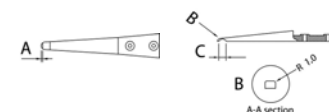

Cat. #	OAL mm	A mm	B mm	C mm	Weight	Description	Alloy	Unit
10004-E22-SM	125	0.50	1.00	2.50	20g	Handle & Tips	Antimagnetic	each
TIP-22-ESD		0.50	1.00	2.50	1g	Replaceable Tips	Black ESD	each

## Tweezers and Replaceable Tips, continued

## WA ESD, continued

## III Style E50

WA1 Handle  
with 50-ESD Tips



Cat. #	OAL mm	A mm	B mm	Weight	Description	Alloy	Unit
10004-E50-SM	115	10.00	8.00	19g	Handle & Tips	Antimagnetic	each
TIP-50-ESD		10.00	8.00	1g	Replaceable Tips	Black ESD	each

## III Style E52

WA1 Handle  
with 52-ESD Tips

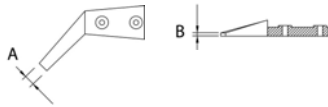

Cat. #	OAL mm	A mm	B mm	Weight	Description	Alloy	Unit
10004-E52-SM	1150	2.50	0.70	19g	Handle & Tips	Antimagnetic	each
TIP-52-ESD		2.50	0.70	1g	Replaceable Tips	Black ESD	each

## III Style E55

WA1 Handle  
with 55-ESD Tips

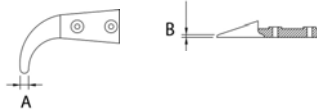

Cat. #	OAL mm	A mm	B mm	Weight	Description	Alloy	Unit
10004-E55-SM	115	2.00	0.70	19g	Handle & Tips	Antimagnetic	each
TIP-55-ESD		2.00	0.70	1g	Replaceable Tips	Black ESD	each

## III Style E57

WA1 Handle  
with 57-ESD Tips



Cat. #	OAL mm	A mm	B mm	Weight	Description	Alloy	Unit
10004-E57-SM	120	1.00	0.70	19g	Handle & Tips	Antimagnetic	each
TIP-57-ESD		1.00	0.70	1g	Replaceable Tips	Black ESD	each

## Technical Tips

## Safety with Common Chemicals in the EM Lab

**Sodium Cacodylate:** contains arsenic (As) and can be absorbed through the skin.  
NOTE: Some buffers (e.g. cacodylate and veronal acetate) contain toxic components, and must be handled with caution. Use gloves at all times and dispose of in appropriate manner

**Aldehydes:** mucus membrane irritant and fixative, shown to cause cancer in the nasal cavity & skin.

**Osmium Tetroxide:** vapors and liquids are toxic, irritate, and fix mucus membranes.

- Handle in a well-ventilated room and open only in a fume hood.
- Handle ampoules with disposable gloves. Use double bottles and seal with parafilm.
- DO NOT hold your breath when using OsO<sub>4</sub>. Your nose is a very sensitive detector of dangerous fumes, and you may be able to detect potential problems, such as the fume hood isn't working, if you breathe normally.

**Propylene Oxide:** Carcinogen similar to aldehydes.

- A very volatile solution. Must be opened and used at room temperature. NEVER HEAT.
- Store in a cool place.

**Embedment Resins:** Irritants and possible carcinogens. Most embedding resins may cause dermatitis.

- When preparing the mixtures and during embedding procedures, ALWAYS use disposable gloves. Cover working areas with paper towel or diapers and wipe spills immediately with alcohol.
- DO NOT use alcohol to remove resins from your skin, it increases penetration. Use soap & water to remove resins.

- Get medical attention for any suspicious skin rash.
- Harden/polymerize all waste resin before disposal.
- For disposing, follow all local/regional requirements and wrap discarded containers, beakers, vials, pipettes, etc., carefully.
- Never pour any plastic containing solutions (e.g., propylene oxide-epon mixture) down the drain. They will harden.

**Lead and Uranyl Acetate:** Heavy metal poisoning.

**DMSO:** Facilitates absorption through the skin of any material contained in it.

**Cryogenics:** Liquid nitrogen and helium are the most common EM lab cryogens and pose several hazards.

1. Never use cryogenics in an enclosed space. Cryogenics displace oxygen from the room, causing asphyxiation.
2. Sealed containers can build up pressure resulting in explosions. Always check that the pressure relief valve is not frozen shut.
3. Direct contact with liquid or equipment exposed to cryogen can cause frostbite and burns.

**Compressed Gas Cylinders:**

ALWAYS secure all cylinders to wall or stable unit using straps or chains.

- NEVER move a cylinder without first securing the cap over the valve.

# DUMONT TWEEZERS

## Tweezers and Replaceable Tips, continued

### WA STD

#### III Style S2

WA1 Handle with 2-STD Tip



Cat. #	OAL mm	A mm	B mm	Weight	Description	Alloy	Unit
10004-S2-SM	130	2.50	1.00	19g	Handle & Tips	Antimagnetic	each
TIP-2-STD		2.50	1.00	1g	Replaceable Tips	Grey STD	each

#### III Style S3

WA1 Handle with 3-STD Tips



Cat. #	OAL mm	A mm	B mm	Weight	Description	Alloy	Unit
10004-S3-SM	125	2.30	35.00	19g	Handle & Tips	Antimagnetic	each
TIP-3-STD		2.30	35.00	1g	Replaceable Tips	Grey STD	each

#### III Style S10A

WA1 Handle with 10A-STD Tips



Cat. #	OAL mm	A mm	B mm	Weight	Description	Alloy	Unit
10004-S10A-SM	125	0.60	0.50	19g	Handle & Tips	Antimagnetic	each
TIP-10A-STD		0.60	0.50	1g	Replaceable Tips	Grey STD	each

#### III Style S15

WA1 Handle with 15-STD Tips



Cat. #	OAL mm	A mm	B mm	Weight	Description	Alloy	Unit
10004-S15-SM	130	0.30	0.30	19g	Handle & Tips	Antimagnetic	each
TIP-15-STD		0.30	0.30	1g	Replaceable Tips	Grey STD	each

#### III Style S17

WA1 Handle with 17-STD Tips



Cat. #	OAL mm	A mm	B mm	Weight	Description	Alloy	Unit
10004-S17-SM	130	1.50	0.35	19g	Handle & Tips	Antimagnetic	each
TIP-17-STD		1.50	0.35	1g	Replaceable Tips	Grey STD	each

#### III Style S52

WA1 Handle with 52-STD Tips



Cat. #	OAL mm	A mm	B mm	Weight	Description	Alloy	Unit
10004-S52-SM	130	2.50	0.70	19g	Handle & Tips	Antimagnetic	each
TIP-52-STD		2.50	0.70	1g	Replaceable Tips	Grey STD	each

#### III Style S55

WA1 Handle with 55-STD Tips



Cat. #	OAL mm	A mm	B mm	Weight	Description	Alloy	Unit
10004-S55-SM	115	2.00	0.70	19g	Handle & Tips	Antimagnetic	each
TIP-55-STD		2.00	0.70	1g	Replaceable Tips	Grey STD	each

#### III Style S57

WA1 Handle with 57-STD Tips



Cat. #	OAL mm	A mm	B mm	Weight	Description	Alloy	Unit
10004-S57-SM	120	1.00	0.70	19g	Handle & Tips	Antimagnetic	each
TIP-57-STD		1.00	0.70	1g	Replaceable Tips	Grey STD	each

## Tweezers and Replaceable Tips, continued

## WA Ceramic

## III Style CA275

WA2 Handle  
with CA275-CW Tips



Cat. #	OAL mm	A mm	B mm	Weight	Description	Alloy	Unit
10004-CA275-SM	133	0.30	0.40	21g	Handle & Tips	Antimagnetic	each
TIP-CA275-CW		0.30	0.40	3g	Replaceable Tips	Black Ceramic	each

## WA Tweezer Handles

These tweezer handles are antimagnetic.

## III Style WA1

For all tips with 4 screws

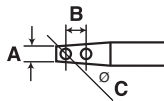

Cat. #	OAL mm	A mm	B mm	C mm	Finish	Alloy	Unit
10004-WA1-SM	105	5.00	8.00	3.20	WA1 Handle	Antimagnetic	each
VIS-PTE-WA1		Screws for WA1 Handle					each

## III Style WA2

Only for CA275-CW tips

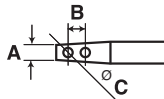

Cat. #	OAL mm	A mm	B mm	C mm	Finish	Alloy	Unit
10004-WA2-SM	105	4.70	5.50	2.10	WA2 Handle	Antimagnetic	each

## III Style WA3

For all tips with 2 screws

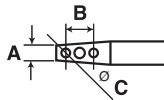

Cat. #	OAL mm	A mm	B mm	C mm	Finish	Alloy	Unit
10004-WA3-SM	105	5.00	8.20	2.50	WA3 Handle	Antimagnetic	each

## Technical Tips

## General Lab Safety

Who is responsible for safety in your laboratory? YOU! You are most responsible for your own safety and that of your coworkers. Here is a list of common good habits that all lab personnel should observe. As always, become familiar with, and follow, your own company's laboratory guide book on lab safety.

## Good Lab Habits

1. Read through the entire protocol before starting, so you know what to expect. Be sure to have the needed chemicals, equipment, and time to complete the task.
2. Identify the hazards and match your level of protection to meet them. Chemicals, toxins, and biological hazards can enter the body via inhalation, ingestion, absorption, and injection. Safety measures and safety wear include:
  - Fume hood
  - Gloves impervious to chemicals being used
  - Safety glasses with side shields
  - Lab coat or apron
  - Closed toe shoes
  - Long pants
3. Treat every chemical as potentially hazardous.
4. Read and pay attention to the Safety Data Sheet (SDS), especially when dealing with unfamiliar chemicals.
5. Make yourself familiar with the locations of safety equipment such as:
  - Showers
  - Fire extinguishers/alarms
  - Spill kits
  - Electrical control panels
  - Emergency phone numbers
6. Work carefully and cleanly! Pay attention to drips and spills and wipe them up appropriately before they get spread around.
7. Gloves protect your hands, but they do not protect other parts of you or other items you touch.
8. Dispose of wastes in designated containers. DO NOT mix hazards!
9. Trust your instincts, if something doesn't look, smell, or seem right, it probably isn't. Check!
10. Have only the chemicals you are currently using out and available. All others should be put away.
11. Do not play around or distract individuals who are handling chemicals or equipment in the lab.

RUBIS TWEEZERS

Rubis Overview

EMS is Proud to represent **Rubis**  
 Innovations from Rubis with a clear focus on cutting-edge laboratory instruments

### High-Tech Tweezers for Laboratory Requirements

*Evolution is what the Rubis development engineers call it when they harmonize ultra-modern technology and traditional Swiss precision engineering in their ground-breaking precision instruments. Continuous innovation in recent years has enabled the premium label//brand to ready its classic tweezers to meet new and exacting demands. With three new developments at once, the experts from South Switzerland are back on the pioneering track: exclusive high-tech surfaces offer substantial added utility and clear customer benefits.*

Ultra-modern nanotechnology closes even the tiniest of pores on the surface of the Nano tweezers. The instrument itself, as all Rubis tweezers, is made from extremely high-grade surgical stainless steel. The Lotus effect, engineered by the nanotechnology, causes dirt, oil, water and other liquids to simply pearl off the steel. This keeps the tweezers perfectly clean, a beneficial feature particularly in a sensitive laboratory setting.

However, the need for hygiene is no longer limited to what the eye can see. Rubis has come up with a unique solution to meet just such exacting requirements in the form of the Ion tweezers. The innovative special coating of the Ion model releases silver ions, which act as an antimicrobial to reliably neutralize bacteria, germs and other pathogens. Unlike other methods, the use of ion technology does not give rise to any resistance. Consequently, it represents a risk-free method of guaranteeing hygiene, even at workstations where instruments are used by several different people.

The third innovation really does "get a grip" on things. The special soft coating of the new Grip tweezers not only provides a non-slip grip, it also improves the handling perceptibly. The easy-grip, soft-touch coating prevents hand fatigue, provides isolation and protects against the influence of heat.

The latest innovation aims for a considerably longer service life. Durax™ tweezers with a tip as hard as 616HV Vickers-hardness are 6 x harder than the tip of a standard stainless steel tweezers. Even with intensive use Rubis Durax™ tweezers retain their original precision. The advanced material properties guarantee higher resistance against normal wear and tear.

The Nano, Ion, Grip and Durax™ tweezers are available exclusively from Rubis. Already operating globally in the watch-making and electronics industries and in the medicine and cosmetics sectors for the past 60 years, these innovations give Rubis a strong point of departure to enter the laboratory products market. "We are highly specialised, possess unique expertise and offer our customers a product programme tailor-made to suit their exacting requirements," explains Fides Baldesberger, proprietor of Rubis. "And this goes for the laboratory products segment now, too." To constantly guarantee the first-rate quality of the products, each hand-made precision instrument and all its details are meticulously checked under magnifier glasses before leaving the workshop. In typical Swiss style, of course: As Fides Baldesberger puts it, "Only tweezers that pass this test carry the Rubis quality label//brand".

#### The company

Rubis is a leading international manufacturer of hand-made precision instruments. The Swiss premium label//brand has been manufacturing and developing high-grade precision instruments in the tradition of Swiss precision engineering at its workshops in Stabio for more than 60 years. Besides boasting an extensive product portfolio, Rubis also makes tools to its customers' own specifications. Although Rubis tweezers were initially manufactured exclusively for the Swiss watch industry, the products are now employed across the globe in a wide range of applications in the electronics industry, in R&D labs, in medicine and in cosmetics. Rubis products are regularly honoured with international awards for the quality of their materials, finish and design. Elaborate handwork, ultra-modern technology, the best raw materials, functional precision and aesthetic form put Rubis in a class of its own.

#### Hand Crafted Precision Tweezers

More than sixty years ago, the first precision tweezers were developed to place ruby stones into watch movements. Since then the brand Rubis has continued to represent precision tools made to authentic Swiss quality standards.

The quality of Rubis product is the result of applying a combination of the latest technology with speed and superior traditional workmanship. Each tweezers is finished by hand under a loupe, to guarantee perfect tips alignment and Swiss top quality. Ideal span, high stability, an ergonomically correct form and resilience of material - best surgical stainless steel, antacid and non-magnetic - accounts for effectiveness and precision.

State-of-the-art technologies and novel materials have been studied for the development of new, extraordinary and innovative products. Tweezers are a simple tool - yet demanding in their specifications. They require continuous engineering and development to keep pace with their applications for the newest and ever changing technologies.

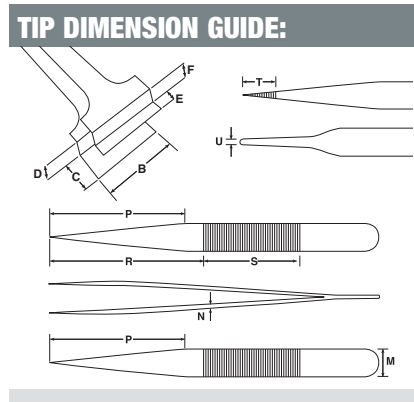

Electron Microscopy Sciences is proud to offer the complete line of Rubis laboratory tweezers:

- Standard SA Steel Tweezers
- Rubis Wafer Tweezers
- Grip Tweezers
- Durax
- Nano-Tweezers
- Ion Tweezers
- Axal

## Rubis High Tech Tweezers for Laboratory Requirements

### Rubis Axal™ Tweezers

The Axal™ line is made from High Cobalt Chromium-Molybdenum Alloy. With a high Vickers hardness, 100% antimagnetic and acid resistant, these tweezers supply long lasting durability and are practically wearproof.

#### III Style SS

135 mm (5 $\frac{3}{8}$ ") Long. M = 8 mm ( $\frac{1}{2}$ ")  
N = 1.5 mm ( $\frac{1}{16}$ ") P = 82 mm (3 $\frac{1}{4}$ ")



**78147-SS** Axal™ SS Tweezer each

#### III Style 1

120 mm (4  $\frac{3}{4}$ ") Long. M = 10 mm ( $\frac{1}{2}$ ")  
N = 1.5 mm ( $\frac{1}{16}$ ") P = 50 mm (2")



**78147-1** Axal™ Style 1 Tweezer each

#### III Style 3

120 mm (4  $\frac{3}{4}$ ") Long. M = 10 mm ( $\frac{1}{2}$ ")  
N = 1.5 mm ( $\frac{1}{16}$ ") P = 50 mm (2")



**78147-3** Axal™ Style 3 Tweezer each

#### III Style 3C

110 mm (4  $\frac{1}{8}$ ") Long. M = 9 mm ( $\frac{1}{2}$ ")  
N = 1.5 mm ( $\frac{1}{16}$ ") P = 43 mm (1 $\frac{3}{4}$ ")



**78147-3C** Axal™ Style 3C Tweezer each

#### III Style 0

120 mm (4  $\frac{3}{4}$ ") Long. M = 10 mm ( $\frac{1}{2}$ ")  
N = 1.5 mm (1/16") P = 51 mm (2")



**78147-0** Axal™ Style 0 Tweezer each

#### III Style 0C 11

110 mm (4  $\frac{1}{8}$ ") Long. M = 9 mm ( $\frac{1}{2}$ ")  
N = 1.5 mm ( $\frac{1}{16}$ ") P = 47 mm (1 $\frac{3}{4}$ ")

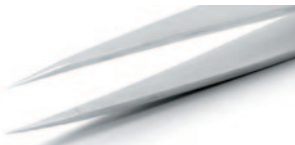

**78147-0C11** Axal™ Style 0C11 Tweezer each

#### III Style 4AB

110 mm (4 $\frac{1}{2}$ ") Long. M = 10 mm ( $\frac{1}{2}$ ")  
N = 1.5 mm ( $\frac{1}{16}$ ") P = 30 mm (1 $\frac{1}{8}$ ")



**78147-4AB** Axal™ Style 4AB Tweezer each

#### III Style F

120 mm (4 $\frac{3}{4}$ ") Long. M = 10 mm ( $\frac{1}{2}$ ")  
N = 1.5 mm ( $\frac{1}{16}$ ") P = 33 mm (1 $\frac{1}{4}$ ")

**78147-F** Axal™ Style F Tweezer each



#### III Style 2A

120 mm (4  $\frac{3}{4}$ ") Long. M = 10 mm ( $\frac{1}{2}$ ")  
N = 1.5 mm ( $\frac{1}{16}$ ") P = 35 mm (1  $\frac{3}{8}$ ")  
U = 2 mm ( $\frac{1}{2}$ ")

**78147-2A** Axal™ Style 2A Tweezer each



#### III Style 2

115 mm (4 $\frac{1}{2}$ ") Long. M = 10 mm ( $\frac{1}{2}$ ")  
N = 1.5 mm ( $\frac{1}{16}$ ") P = 34 mm (1 $\frac{1}{8}$ ")

**78147-2** Axal™ Style 2 Tweezer each



#### III Style 5

120 mm (4  $\frac{3}{4}$ ") Long. M = 10 mm ( $\frac{1}{2}$ ")  
N = 1.5 mm ( $\frac{1}{16}$ ") P = 30 mm (1 $\frac{1}{16}$ ")

**78147-5** Axal™ Style 5 Tweezer each



#### III Style 4

110 mm (4 $\frac{1}{8}$ ") Long. M = 10 mm ( $\frac{1}{2}$ ")  
N = 1.5 mm ( $\frac{1}{16}$ ") P = 30 mm (1 $\frac{1}{16}$ ")

**78147-4** Axal™ Style 4 Tweezer each



#### III Style 5A

115 mm (4 $\frac{1}{2}$ ") Long. M = 10 mm ( $\frac{1}{2}$ ")  
N = 1.5 mm ( $\frac{1}{16}$ ") P = 34 mm (1 $\frac{1}{8}$ ")

**78147-5A** Axal™ Style 5 Tweezer each



#### III Style 7

120 mm (4  $\frac{3}{4}$ ") Long. M = 11 mm ( $\frac{1}{2}$ ")  
N = 1.5 mm ( $\frac{1}{16}$ ") P = 34 mm (1 $\frac{1}{8}$ ")

**78147-7** Axal™ Style 7 Tweezer each



#### III Style 7A

115 mm (4 $\frac{1}{2}$ ") Long. M = 10 mm ( $\frac{1}{2}$ ")  
N = 1.5 mm ( $\frac{1}{16}$ ") P = 34 mm (1 $\frac{1}{8}$ ")

**78147-7A** Axal™ Style 7A Tweezer each





# RUBIS TWEEZERS

## Rubis High Tech Tweezers for Laboratory Requirements (continued)

### Rubis Ion Tweezers

Ultra-modern nanotechnology closes even the tiniest of pores on the surface and this innovation has resulted in the cleanest tweezers surface ever produced. Made from the finest stainless steel grade, the Lotus effect repels dirt, oil, water and other liquids. These tweezers are a perfect companion in the clean room or any sensitive laboratory areas where contaminant free tools is required.

#### III Style SS

Length: 135mm



Catalog No.	M mm	N mm	P mm	U mm	Qty.
78146-SS	8.00	1.50	82.00		each

#### III Style 1

Length: 120mm



Catalog No.	M mm	N mm	P mm	U mm	Qty.
78146-1	10.00	1.50	50.00		each

#### III Style 3

Length: 120mm



Catalog No.	M mm	N mm	P mm	U mm	Qty.
78146-3	10.00	1.50	50.00		each

#### III Style 3C

Length: 110mm



Catalog No.	M mm	N mm	P mm	U mm	Qty.
78146-3C	9.00	1.50	43.00		each

#### III Style 0

Length: 120mm



Catalog No.	M mm	N mm	P mm	U mm	Qty.
78146-0	10.00	1.50	51.00		each

#### III Style 00

Length: 115mm



Catalog No.	M mm	N mm	P mm	U mm	Qty.
78146-00	10.00	1.50	46.00	0.50	each

#### III Style 2A

Length: 120mm



Catalog No.	M mm	N mm	P mm	U mm	Qty.
78146-2A	10.00	1.50	35.00	2.00	each

#### III Style 5

Length: 120mm



Catalog No.	M mm	N mm	P mm	U mm	Qty.
78146-5	10.00	1.50	30.00		each

#### III Style 5A

Length: 115mm



Catalog No.	M mm	N mm	P mm	U mm	Qty.
78146-5A	10.00	1.50	34.00		each

#### III Style 7

Length: 120mm



Catalog No.	M mm	N mm	P mm	U mm	Qty.
78146-7	11.00	1.50	34.00		each

## You may also need... Tweezer Accessories

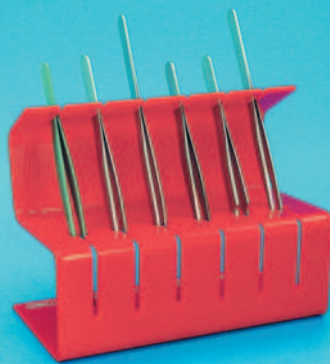

### III Tweezer Holder

#### EMS EXCLUSIVE

Holds 6 tweezers. Keeps tips protected in an easy to reach position.

Cat. No.	Description	Qty.
72900	Tweezer Holder	each

### III Tweezers Protection Caps

These caps which are in the shape of the tweezer tip are made from Polyethylene and are used to protect the tweezers tips from damage.



Cat. No.	Description	Qty.
72904-12	Tweezers Protection Caps	12/pk.

## Rubis High Tech Tweezers for Laboratory Requirements (continued)

### Rubis Grip Tweezers

This special soft coating provides a non-slip grip and improves the handling of the tweezers. The soft-coating prevents hand fatigue, and protects the hand from heat and cold. Made from the finest stainless steel grade.

#### III Style SS

Length: 135mm



Catalog No.	M mm	N mm	P mm	U mm	Qty.
78144-SS	8.00	1.50	82.00		each

#### III Style 1

Length: 120mm



Catalog No.	M mm	N mm	P mm	U mm	Qty.
78144-1	10.00	1.50	50.00		each

#### III Style 3

Length: 120mm



Catalog No.	M mm	N mm	P mm	U mm	Qty.
78144-3	10.00	1.50	50.00		each

#### III Style 3C

Length: 110mm



Catalog No.	M mm	N mm	P mm	U mm	Qty.
78144-3C	9.00	1.50	43.00		each

#### III Style 0

Length: 120mm



Catalog No.	M mm	N mm	P mm	U mm	Qty.
78144-0	10.00	1.50	51.00		each

#### III Style 00

Length: 115mm



Catalog No.	M mm	N mm	P mm	U mm	Qty.
78144-00	10.00	1.50	46.00	0.50	each

#### III Style 2A

Length: 120mm



Catalog No.	M mm	N mm	P mm	U mm	Qty.
78144-2A	10.00	1.50	35.00	2.00	each

#### III Style 5

Length: 120mm



Catalog No.	M mm	N mm	P mm	U mm	Qty.
78144-5	10.00	1.50	30.00		each

#### III Style 5A

Length: 115mm



Catalog No.	M mm	N mm	P mm	U mm	Qty.
78144-5A	10.00	1.50	34.00		each

#### III Style 7

Length: 120mm



Catalog No.	M mm	N mm	P mm	U mm	Qty.
78144-7	11.00	1.50	34.00		each

### III The Tweezer Repair Kit

This repair kit allows you to straighten, sharpen, and repair your tweezers that have been damaged or have become dull. Instructions are included with the kit

The kit includes:

- 1 Sharpening stone
- Chain nose pliers
- Instrument Oil, 50 ml
- Ten O-rings

Cat. No.	Description	Qty.
72892-10	The Tweezer Repair Kit	kit



RUBIS TWEEZERS

Rubis High Tech Tweezers for Laboratory Requirements

Rubis DURAX™, the Resistant Tweezers

With a 616HV Vickers-hardness, the tip of Rubis DURAX™ tweezers is six times harder than the tip of a standard steel tweezers. Even with intensive use, Rubis DURAX™ tweezers retain their original precision. The advanced material properties guarantee higher resistance against normal wear and tear, providing a considerably longer service life. Their specially-hardened chrome-magnesium steel is also used in the manufacture of surgical instruments.

III Style 0



Catalog No.	OAL mm	M mm	N mm	P mm	U mm	Qty.
78149-0	120	10.00	1.50	51.00		each

III Style 4



Catalog No.	OAL mm	M mm	N mm	P mm	U mm	Qty.
78149-4	110	10.00	1.50	30.00		each

III Style 0C11



Catalog No.	OAL mm	M mm	N mm	P mm	U mm	Qty.
78149-0C11	110	9.00	1.50	47.00		each

III Style 5



Catalog No.	OAL mm	M mm	N mm	P mm	U mm	Qty.
78149-5	120	10.00	1.50	30.00		each

III Style 1



Catalog No.	OAL mm	M mm	N mm	P mm	U mm	Qty.
78149-1	120	10.00	1.50	50.00		each

III Style 5A



Catalog No.	OAL mm	M mm	N mm	P mm	U mm	Qty.
78149-5A	115	10.00	1.50	34.00		each

III Style 2



Catalog No.	OAL mm	M mm	N mm	P mm	U mm	Qty.
78149-2	115	10.00	1.50	34.00		each

III Style 7



Catalog No.	OAL mm	M mm	N mm	P mm	U mm	Qty.
78149-7	120	11.00	1.50	34.00		each

III Style 2A



Catalog No.	OAL mm	M mm	N mm	P mm	U mm	Qty.
78149-2A	120	10.00	1.50	35.00	2.00	each
	120	8.00	1.50	82.00		each

III Style 7E



Catalog No.	OAL mm	M mm	N mm	P mm	U mm	Qty.
78149-7E	115	10.00	1.50	34.00		each

III Style 3



Catalog No.	OAL mm	M mm	N mm	P mm	U mm	Qty.
78149-3	120	10.00	1.50	50.00		each

III Style F



Catalog No.	OAL mm	M mm	N mm	P mm	U mm	Qty.
78149-F	120	10.00	1.50	33.00	2.50	each

III Style 3C



Catalog No.	OAL mm	M mm	N mm	P mm	U mm	Qty.
78149-3C	110	9.00	1.50	43.00		each

III Style SS



Catalog No.	OAL mm	M mm	N mm	P mm	U mm	Qty.
78149-SS	135	8.00	1.50	82.00		each

## Rubis High Tech Tweezers for Laboratory Requirements (continued)

### Rubis Nano Tweezers

Ultra-modern nanotechnology closes even the tiniest of pores on the surface and this innovation has resulted in the cleanest tweezers surface ever produced. Made from the finest stainless steel grade, the Lotus effect repels dirt, oil, water and other liquids. These tweezers are a perfect companion in the clean room or any sensitive laboratory areas where contaminant free tools is required.

#### III Style SS

Length: 135mm



Catalog No.	M mm	N mm	P mm	U mm	Qty.
78148-SS	8.00	1.50	82.00		each

#### III Style 00

Length: 115mm



Catalog No.	M mm	N mm	P mm	U mm	Qty.
78148-00	10.00	1.50	46.00	0.50	each

#### III Style 1

Length: 120mm



Catalog No.	M mm	N mm	P mm	U mm	Qty.
78148-1	10.00	1.50	50.00		each

#### III Style 2A

Length: 120mm



Catalog No.	M mm	N mm	P mm	U mm	Qty.
78148-2A	10.00	1.50	35.00	2.00	each

#### III Style 3

Length: 120mm



Catalog No.	M mm	N mm	P mm	U mm	Qty.
78148-3	10.00	1.50	50.00		each

#### III Style 5

Length: 120mm



Catalog No.	M mm	N mm	P mm	U mm	Qty.
78148-5	10.00	1.50	30.00		each

#### III Style 3C

Length: 110mm



Catalog No.	M mm	N mm	P mm	U mm	Qty.
78148-3C	9.00	1.50	43.00		each

#### III Style 5A

Length: 115mm



Catalog No.	M mm	N mm	P mm	U mm	Qty.
78148-5A	10.00	1.50	34.00		each

#### III Style 0

Length: 120mm



Catalog No.	M mm	N mm	P mm	U mm	Qty.
78148-0	10.00	1.50	51.00		each

#### III Style 7

Length: 120mm



Catalog No.	M mm	N mm	P mm	U mm	Qty.
78148-7	11.00	1.50	34.00		each

RUBIS TWEEZERS

Rubis High Tech Tweezers for Laboratory Requirements

**Rubis ESD Rubber-Handle Tweezers**

With an innovative streamlined handle that enhances productivity

**Innovative Design:** Forget about those bulky rubber handles that negatively affect your performance. This ergonomic and functional Rubis-Design ensures operators maximum ease of handling, extended durability, and comfort with the benefits of a soft velvety touch.

**Innovative Material:** High-tech, velvety-soft, and ESD-safe. This TPV rubber material has been developed to provide heat insulation, effortless handling, and extended durability.

**Application:** Rubis ESD Rubber-Handle Tweezers are particularly recommended for cleanrooms and other controlled environments. They provide good thermic insulation from heat, which makes them perfect for soldering and desoldering applications.

III Style 2B



Antimagnetic/Anti-acid SS  
**Tips:** curved, round, flat, fine.  
**OAL:** 125mm.  
**Tips thickness A:** 0.7mm.  
**Tips width B:** 0.4mm.

Cat No.	Description	Qty.
78200-2B	Rubis ESD Rubber-Handle Tweezers, Style 2B	each

III Style 00

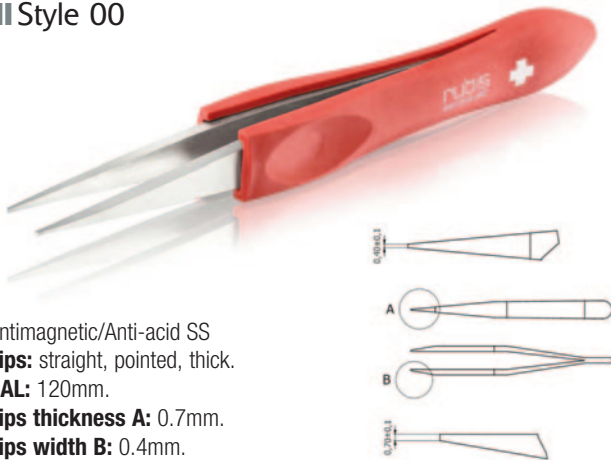

Antimagnetic/Anti-acid SS  
**Tips:** straight, pointed, thick.  
**OAL:** 120mm.  
**Tips thickness A:** 0.7mm.  
**Tips width B:** 0.4mm.

Cat No.	Description	Qty.
78200-00	Rubis ESD Rubber-Handle Tweezers, Style 00	each

III Style 3



Antimagnetic/Anti-acid SS  
**Tips:** straight, pointed, ultra fine.  
**OAL:** 125mm.  
**Tips thickness A:** 0.7mm.  
**Tips width B:** 0.4mm.

Cat No.	Description	Qty.
78200-3	Rubis ESD Rubber-Handle Tweezers, Style 3	each

III Style 2A



Antimagnetic/Anti-acid SS  
**Tips:** straight, round, flat, fine.  
**OAL:** 125mm.  
**Tips thickness A:** 0.7mm.  
**Tips width B:** 0.4mm.

Cat No.	Description	Qty.
78200-2A	Rubis ESD Rubber-Handle Tweezers, Style 2A	each

III Style 3C



Antimagnetic/Anti-acid SS  
**Tips:** straight, pointed, ultra fine.  
**OAL:** 115mm.  
**Tips thickness A:** 0.7mm.  
**Tips width B:** 0.4mm.

Cat No.	Description	Qty.
78200-3C	Rubis ESD Rubber-Handle Tweezers, Style 3C	each

Rubis High Tech Tweezers for Laboratory Requirements

Rubis ESD Rubber-Handle Tweezers (cont.)

III Style 5



Antimagnetic/Anti-acid SS  
**Tips:** straight, needle pointed, ultra fine.  
**OAL:** 120mm.  
**Tips thickness A:** 0.7mm.  
**Tips width B:** 0.4mm.

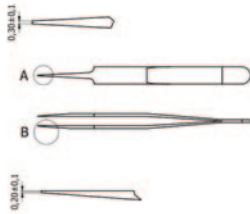

Cat No.	Description	Qty.
78200-5	Rubis ESD Rubber-Handle Tweezers, Style 5	each

III Style 5AR



High Precision, Antimagnetic/Anti-acid SS  
**Tips:** angled, bent, pointed, ultra fine.  
**OAL:** 115mm.  
**Tips thickness A:** 0.7mm.  
**Tips width B:** 0.4mm.

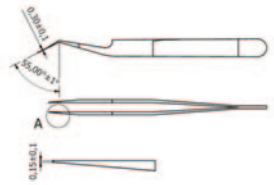

Cat No.	Description	Qty.
78200-5AR	Rubis ESD Rubber-Handle Tweezers, Style 5AR	each

III Style 5A



Antimagnetic/Anti-acid SS  
**Tips:** angled, bent, pointed, ultra fine.  
**OAL:** 115mm.  
**Tips thickness A:** 0.7mm.  
**Tips width B:** 0.4mm.

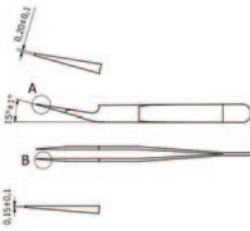

Cat No.	Description	Qty.
78200-5A	Rubis ESD Rubber-Handle Tweezers, Style 5A	each

III Style 7



High Precision, Antimagnetic/Anti-acid SS  
**Tips:** curved, pointed, ultra fine.  
**OAL:** 125mm.  
**Tips thickness A:** 0.7mm.  
**Tips width B:** 0.4mm.

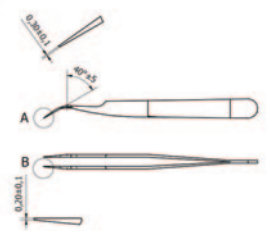

Cat No.	Description	Qty.
78200-7	Rubis ESD Rubber-Handle Tweezers, Style 7	each

Congratulations to Rubis on their Anniversary!

In celebration of 60 years of exceptional quality in the manufacturing of precision tweezers we are offering this special Tweezers Set Case...



III Rubis Anniversary Electronics Tweezers Set Case

RUBIS Tweezers Set Case has been designed to offer a safe place to store tweezers. With a perfect combination of hard cover and adaptive foam on the inside, tweezers will always be protected, whether it be from accidental dropping, or external agents like dirt, acids, or solvents.

RUBIS Tweezers Set Case, with its compact design (185 x 140 x 20mm) and light weight (100g empty) is the perfect way to transport your tweezers securely.

This special case set come with five of the most popular tweezers used in the electronics industry, including **00-SA, 2A-SA, 3C-SA, 5-SA, and 7-SA.**

The case can be also purchased separately.

Cat No.	Description	Qty.
78190-05	Rubis Anniversary Electronics Tweezers Set Case	each
78190-06	Rubis Anniversary Tweezers Case only	each



# RUBIS TWEEZERS

## Rubis Precision Tweezers

Made from austenitic, acid-proof stainless steel, 100% anti-magnetic (SA). Also resist to hydrogen fluoride (HF) and nitric acid. Melting point 1400°C.

- These tweezers engineered for a **NON-SLIP GRIP.**
- Light weight –prevents hand fatigue.
- Sensuous touch and functional design.
- Ultra-fine precision tips.

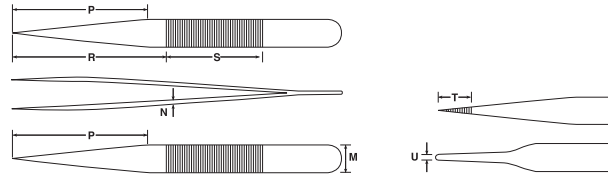

### III Model 1G, SA



Catalog No.	Description	OAL mm	M mm	N mm	P mm	U mm	Qty.
78170-1G	Rubis Tweezer Model 1G	120	10.00	1.50	50.00		each

### III Model 2AG, SA



Catalog No.	Description	OAL mm	M mm	N mm	P mm	U mm	Qty.
78170-2AG	Grip Tweezers Model 2AG	120	10.00	1.50	50.00	2.00	each

### III Model 3G, SA



Catalog No.	Description	OAL mm	M mm	N mm	P mm	U mm	Qty.
78170-3G	Rubis Tweezer Model 3G	120	10.00	1.50	50.00		each

### III Model 3CG, SA



Catalog No.	Description	OAL mm	M mm	N mm	P mm	U mm	Qty.
78170-3CG	Rubis Tweezer Model 3CG	110	9.00	1.50	43.00		each

### III Model 4G, SA



Catalog No.	Description	OAL mm	M mm	N mm	P mm	U mm	Qty.
78170-4G	Rubis Tweezer Model 4G	110	10.00	1.50	30.00		each

### III Model 5G, SA



Catalog No.	Description	OAL mm	M mm	N mm	P mm	U mm	Qty.
78170-5G	Rubis Tweezer Model 5G	110	9.00	1.50	30.00		each

### III Model 5AG, SA



Catalog No.	Description	OAL mm	M mm	N mm	P mm	U mm	Qty.
78170-5AG	Rubis Tweezer Model 5AG	110	9.00	1.50	30.00		each

### III Model 5ARG, SA



Catalog No.	Description	OAL mm	M mm	N mm	P mm	U mm	Qty.
78170-5ARG	Rubis Tweezer Model 5AG	115	10.00	1.50	34.00		each

### III Model 7G, SA



Catalog No.	Description	OAL mm	M mm	N mm	P mm	U mm	Qty.
78170-7G	Rubis Tweezer Model 5AG	115	10.00	1.50	34.00		each

## Rubis Specialty Tweezers

Made from austenitic, acid-proof stainless steel, 100% anti-magnetic (SA). Also resist to hydrogen fluoride (HF) and nitric acid. Melting point 1400°C

- These tweezers are long and strong.
- Knurled Handle – non slip
- Serrated tips and with or without guide pin.

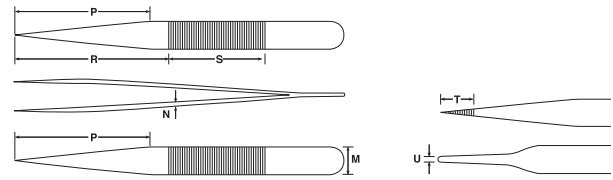

### III Model 232, SA



Catalog No.	Description	OAL mm	M mm	N mm	P mm	R mm	S mm	T mm	U mm	Qty.
78174-1G	Rubis Tweezer Model 232	158	9.00	2.00	80.00	58.00	44.00	17.00	1.70	each

### III Model 524, SA



Catalog No.	Description	OAL mm	M mm	N mm	P mm	R mm	S mm	T mm	U mm	Qty.
78174-524	Rubis Tweezer Model 524	137	10.00	1.50	60.00	52.00	35.00	15.00	1.00	each

### III Model 615, SA



Catalog No.	Description	OAL mm	M mm	N mm	P mm	R mm	S mm	T mm	U mm	Qty.
78174-615	Rubis Tweezer Model 615	155	8.00	2.00	—	57.00	41.00	157.00	1.00	each

### III Model 616, SA



Catalog No.	Description	OAL mm	M mm	N mm	P mm	R mm	S mm	T mm	U mm	Qty.
78174-616	Rubis Tweezer Model 616	162	9.00	2.00	—	66.00	45.00	15.00	1.00	each

### III Model B00, SA



Catalog No.	Description	OAL mm	M mm	N mm	P mm	R mm	S mm	T mm	U mm	Qty.
78174-B00	Rubis Tweezer Model B00	140	9.00	1.50	60.00	52.00	35.00	17.00	2.50	each

### III Model L/Black, SA



Catalog No.	Description	OAL mm	M mm	N mm	P mm	R mm	S mm	T mm	U mm	Qty.
78174-LB	Rubis Tweezer Model L/Black	158	10.00	1.50	65.00	45.00	35.00	13.00	1.00	each

### III Model 6151, SA with plastic insulated handle



Catalog No.	Description	OAL mm	M mm	N mm	P mm	R mm	S mm	T mm	U mm	Qty.
78174-6151	Rubis Tweezer Model 6151	140	11.00	1.50	—	—	—	15.00	2.00	each

### III Model 1K6 Micro Tweezers



Cat. No.	Description	Qty.
78180-1K6	Rubis Micro Tweezers, 1K603	each

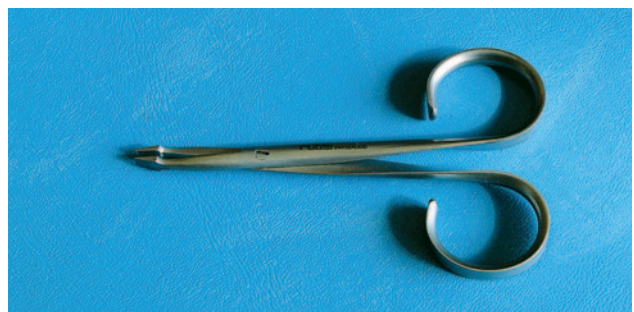



## RUBIS TWEEZERS

## Rubis Standard SA Steel Tweezers

With more than fifty years of experience, RUBIS tweezers represents authentic Swiss quality. The material used in these tweezers is SA steel, which is acid-proof, stainless steel, 100% antimagnetic and it is resistant to HF and nitric acid.

### III Style 00B

Thick and flat, medium sharp and strong tips. Ideal for heavy-duty use. Serrated handle. Length 110mm (4½")

<b>78130-01</b>	Rubis #00B Tweezers	each
<b>78130-12</b>	Rubis #00B Tweezers	dozen

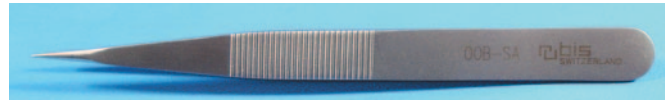

### III Style 00D

Same as #00B above with serrated tips and handle. Length 120mm (4¾")

<b>78131-01</b>	Rubis #00D Tweezers	each
<b>78131-12</b>	Rubis #00D Tweezers	dozen



### III Style 3L

Very sharp, well-groomed points with fine finish. Comes with a unique finger actuated locking device. Length 110mm (4½")

<b>78135-01</b>	Rubis #3L Tweezers	each
<b>78135-12</b>	Rubis #3L Tweezers	dozen



### III Style 5

Super fine points. Length 110mm (4½")

<b>78138-01</b>	Rubis #5 Tweezers	each
<b>78138-12</b>	Rubis #5 Tweezers	dozen



### III Style 5L

Same as #5 but comes with finger actuated locking device. Length 110mm (4½")

<b>78139-01</b>	Rubis #5L Tweezers	each
<b>78139-12</b>	Rubis #5L Tweezers	dozen



### III Style 5B

Same as #5, but with 35 degree curved tips. Length 110mm (4½")

<b>78140-01</b>	Rubis #5B Tweezers	each
<b>78140-12</b>	Rubis #5B Tweezers	dozen



### III Style 5C

Same as #5, but with round curved tips. Length 110mm (4½")

<b>78141-01</b>	Rubis #5C Tweezers	each
<b>78141-12</b>	Rubis #5C Tweezers	dozen



### III Style H

Short and wide with fine tips. Length 90mm (3½")

<b>78150-01</b>	Rubis H Tweezers	each
<b>78150-12</b>	Rubis H Tweezers	dozen



### III Style Oc9

Short, flat and fine points. Length 90mm (3½")

<b>78152-01</b>	Rubis Oc9 Tweezers	each
<b>78152-12</b>	Rubis Oc9 Tweezers	dozen



### III Style 3M

Pointed, thin and fine mini-tweezers. Length 70mm (2¾")

<b>78154-01</b>	Rubis 3M Tweezers	each
<b>78154-12</b>	Rubis 3M Tweezers	dozen



## Rubis Reinforced Plastic Tweezers

Rubis reinforced plastic tweezers with many unique features:

- **Material:** PBTP (Polybutylenterephthalate) with 20% fiber-glass.
- Good resistance to chemicals and acids.
- Highly isolating.
- Withstands temperatures up to 200°C.

### III Style K2a

Flat tips. Length: 120mm (4¾")



78190-01	Rubis K2a Plastic Tweezers	each
78190-12	Rubis K2a Plastic Tweezers	dozen

### III Style K6

Fine, strong hook tips. Length: 120mm (4¾")



78191-01	Rubis K6 Plastic Tweezers	each
78191-12	Rubis K6 Plastic Tweezers	dozen

### III Style K7

Pointed, flat-contact-tips. Length: 120mm (4¾")



78192-01	Rubis K7 Plastic Tweezers	each
78192-12	Rubis K7 Plastic Tweezers	dozen

### III Style K35a

Flat, strong tips. Length: 120mm (4¾")



78193-01	Rubis K35a Plastic Tweezers	each
78193-12	Rubis K35a Plastic Tweezers	dozen

### III Style KR

Flat and thin, flat-contact- tips. Length: 120mm (4¾")



78194-01	Rubis KR Plastic Tweezers	each
78194-12	Rubis KR Plastic Tweezers	dozen

## Tech Plus Tweezers

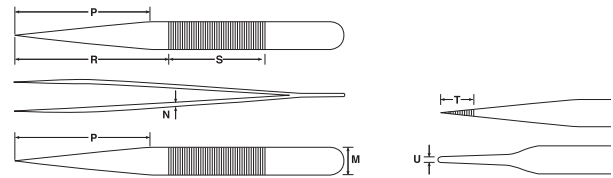

### III Style 2A

Round tip. Length: 120mm



Catalog No.	Description	M mm	N mm	P mm	Qty.
7800-2A	Style 2A	10.00	1.50	35.00	each

### III Style 3

Ultra fine straight pointed precision tip; edges on the outside rounded off. Length: 120mm



Catalog No.	Description	M mm	N mm	P mm	Qty.
7800-3	Style 3	10.00	1.50	50.00	each

### III Style 5

Super thin, ultra fine pointed tips. Length: 110mm



Catalog No.	Description	M mm	N mm	P mm	Qty.
7800-5	Style 5	10.00	1.50	30.00	each

### III Style 7

Curved and thin, ultra fine pointed tips. Length: 115mm



Catalog No.	Description	M mm	N mm	P mm	Qty.
7800-7	Style 7	11.00	1.50	34.00	each

### III Style SS

Extra long, slim, ultra fine straight pointed precision tip.. Length: 135mm



Catalog No.	Description	M mm	N mm	P mm	Qty.
7800-SS	Style SS	8.00	1.50	83.00	each

RUBIS TWEEZERS

Wafer Tweezers

Made from SA steel with serrated handles. These tweezers are specially designed to handle different fragile and delicate materials of gallium or silicon wafers. They have a smooth polished non-glare surface with a satin finish. The tweezers have stopping pins turned up on lateral edges and graduated lower paddles prevent the wafer from slipping. The tweezers are also available in Peek material. Peek: An ESD Safe, 10°Ω x cm. Soft, conductive fiber, with heat resistance up to 250°C (short exposure 300°C). (Not compatible with nitric and sulfuric acids.)

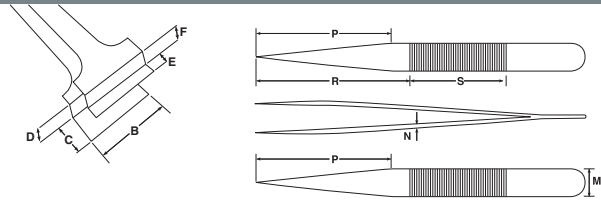

III Style 2LB/4

No teeth.



Catalog No.	Description	OAL mm	B mm	C mm	D mm	E mm	F mm	M mm	N mm	R mm	S mm	Qty.
78220-01	Rubis Tweezer Style 2LB/4	128	12.50	8.00	3.00	2.00	4.00	9.00	2.00	48.00	42.00	each

III Style 39S-4

4 teeth, lower paddle perforated.



Catalog No.	Description	OAL mm	B mm	C mm	D mm	E mm	F mm	M mm	N mm	R mm	S mm	Qty.
78225-01	Rubis Tweezer Style 39S	128	12.50	10.00	—	2.00	6.00	9.00	1.50	48.00	42.00	each

III Style 41LB-2

2 teeth. Flat lower paddle.



Catalog No.	Description	OAL mm	B mm	C mm	D mm	E mm	F mm	M mm	N mm	R mm	S mm	Qty.
78226-01	Rubis Tweezer Style 41LB-2	128	6.00	7.00	—	2.00	3.00	9.00	1.50	52.00	42.00	each

III Style 41LB-5

5 teeth. Flat lower paddle.



Catalog No.	Description	OAL mm	B mm	C mm	D mm	E mm	F mm	M mm	N mm	R mm	S mm	Qty.
78229-01	Rubis Tweezer Style 41LB-5	132	16.00	9.00	—	2.00	3.00	11.00	2.00	52.00	42.00	each

III Style 42LB6

6 teeth. Step up lower paddle



Catalog No.	Description	OAL mm	B mm	C mm	D mm	E mm	F mm	M mm	N mm	R mm	S mm	Qty.
78237-01	Rubis Tweezer Style 42LB6	130	19.50	8.00	3.00	3.00	4.00	11.00	2.00	52.00	42.00	each

III Style 43LB-8-Peek

Clean-room compatible.



Catalog No.	Description	OAL mm	B mm	C mm	D mm	E mm	F mm	M mm	N mm	R mm	S mm	Qty.
78239-01	Rubis Tweezer Style 43LB-8-Peek	138	27.00	21.00	4.00	6.00	5.00	11.00	1.50	61.00	35.00	each

III Style 43LB-4-Peek

Clean-room compatible.



Catalog No.	Description	OAL mm	B mm	C mm	D mm	E mm	F mm	M mm	N mm	R mm	S mm	Qty.
78240-0	Rubis Tweezer Style 43LB-4-Peek	138	13.00	21.00	4.00	6.00	5.00	11.00	1.50	61.00	35.00	each

III Style 43LB-10

10 teeth. Flat lower paddle with opening controller.



Catalog No.	Description	OAL mm	B mm	C mm	D mm	E mm	F mm	M mm	N mm	R mm	S mm	Qty.
78241-01	Rubis Tweezer Style 43LB-10	190	33.50	20.00	7.00	2.00	3.00	13.00	2.00	77.00	42.00	each

# Follow us on Social Media...



At Electron Microscopy Sciences, we love sharing our knowledge and experience with our customers. And with social media, there are even more ways to reach out. But we also love hearing from YOU! Either way, there's plenty to see, share, and enjoy...

- Webinar & Trade Show Information
- New Products
- News, Polls, & Contests
- Technical Notes from Stacie
- Networking with fellow researchers
- Instructional Video
- ...and lots more

*We hope to see you there!*



**Electron  
Microscopy  
Sciences**

P.O. Box 550 • 1560 Industry Rd.  
Hatfield, PA 19440

Tel: (215) 412-8400

Fax: (215) 412-8450

email: [info@emsdiasum.com](mailto:info@emsdiasum.com)  
or [stacie@ems-secure.com](mailto:stacie@ems-secure.com)

[www.emsdiasum.com](http://www.emsdiasum.com)

The most comprehensive source for all fields of microscopy and general laboratory research

# Electron Microscopy Sciences

OUR MAIN INTERACTIVE WEBSITE:

[www.emsdiasum.com](http://www.emsdiasum.com)

Follow us on...



 TO REQUEST A COPY OF OUR FULL LINE CATALOG:  
[www.emsdiasum.com/requests/catalog](http://www.emsdiasum.com/requests/catalog)

 TO VIEW OUR DIGITAL FULL LINE CATALOG:  
[catalog.emsdiasum.com](http://catalog.emsdiasum.com)

 ...OR SCAN HERE:



**Electron Microscopy Sciences**  
P.O. Box 550 • 1560 Industry Rd.  
Hatfield, Pa 19440  
Tel: (215) 412-8400  
Fax: (215) 412-8450  
email: [info@emsdiasum.com](mailto:info@emsdiasum.com)  
or [stacie@ems-secure.com](mailto:stacie@ems-secure.com)

